

COLOrband PiX™

User Manual

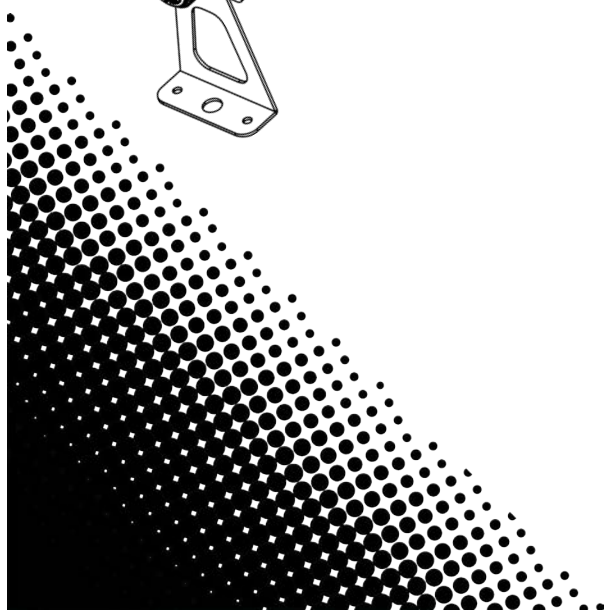

CHAUVET®
Value • Innovation • Performance
It's **Green** Thinking.™

TABLE OF CONTENTS

1. Before You Begin.....	3
What Is Included	3
Unpacking Instructions	3
Claims	3
Text Conventions	3
Icons	3
Document Information	3
Product at a Glance.....	4
Safety Notes	4
2. Introduction.....	5
Product Overview.....	5
Product Dimensions	5
3. Setup	6
AC Power.....	6
Fuse Replacement.....	6
Power Linking	7
Mounting	8
Orientation.....	8
Rigging	8
CBB-6 Instructions	9
4. Operation	10
Control Panel Operation	10
Menu Map	10
Configuration (DMX).....	11
DMX Personalities and Starting Address.....	11
Sectional Control.....	11
DMX Channel Assignments and Values.....	12
7-CH.....	12
3-CH.....	12
4-CH.....	12
6-CH.....	13
9-CH.....	13
12-CH.....	14
18-CH.....	14
36-CH.....	15
Configuration (Standalone).....	16
Static Color Mode	16
Automatic Mode.....	16
Custom Static Color Mode.....	16
Master/Slave Mode	17
5. Technical Information	17
Product Maintenance	17
Contact Us	18
Returns	18
6. Technical Specifications	19

1. BEFORE YOU BEGIN

What Is Included

- 1 x COLORband PiX™
- 1 x Power Cord
- 2 x L-Brackets
- 1 x Warranty Card
- 1 x Quick Reference Guide

Unpacking Instructions

Immediately upon receipt, carefully unpack the product and check the box to make sure you have received all the parts indicated above in good condition.

Claims



If the box or contents (the product and included accessories) appear damaged from shipping, or show signs of mishandling, upon receipt notify the carrier immediately, not CHAUVET®. Failure to do so in a timely manner may invalidate your claim with the carrier. In addition, keep the container and all the packing material for inspection.

For other issues such as missing components or parts, damage not related to shipping, or concealed damage, file a claim with CHAUVET® within 7 days of receiving the merchandise.

Text Conventions

Convention	Meaning
1~512	A range of values
50/60	A set of values of which only one can be chosen
Settings	A menu option not to be modified
Menu > Settings	A sequence of menu options to be followed
<ENTER>	A key to be pressed on the product's control panel
ON	A value to be entered or selected

Icons

Icon	Meaning
	Critical installation, configuration, or operation information. Failure to comply with this information may make the fail to operate, damage it, or cause harm to the user.
	Important installation or configuration information. Failure to comply with this information could make the product not work correctly.
	Useful information.

Document Information

The information and specifications contained in this document are subject to change without notice. CHAUVET® assumes no responsibility or liability for any errors or omissions that may appear in this manual. CHAUVET® reserves the right to update the existing document or to create a new document to correct any errors or omissions.

You can download the latest version of this document from www.chauvetlighting.com.

© Copyright 2012 CHAUVET®. All rights reserved.

Electronically published by CHAUVET® in the United States of America.

Author	Date	Editor	Date
A. Diaz	6/18/12	S. Graham	6/20/12

Product at a Glance

Use on Dimmer	⊘	Auto Programs	✓
Outdoor Use	⊘	Auto-ranging Power Supply	✓
Sound Activated	✓	Replaceable Fuse	✓
DMX	✓	User Serviceable	⊘
Master/Slave	✓	Duty Cycle	⊘

Safety Notes

Please read the following Safety Notes carefully before working with the product. The Notes include important safety information about installation, usage, and maintenance.



- Always connect the product to a grounded circuit to avoid the risk of electrocution.
- Always disconnect the product from the power source before cleaning or replacing the fuse.
- Avoid direct eye exposure to the light source while the product is on.
- Make sure the power cord is not crimped or damaged.
- Never disconnect the product from power cord by pulling or tugging on the cord.
- If mounting the product overhead, always secure to a fastening device using a safety cable.
- Make sure there are no flammable materials close to the product during operation.
- Do not touch the product's housing when operating because it may be very hot.



- Always make sure that the voltage of the outlet to which you are connecting the product is within the range stated on the decal or rear panel of the product.
- The product is for indoor use only! (IP20) To prevent risk of fire or shock, do not expose the product to rain or moisture.
- Always install the product in a location with adequate ventilation, at least 20 in (50 cm) from adjacent surfaces.
- Be sure that no ventilation slots on the product's housing are blocked.
- Never connect the product to a dimmer.
- Make sure to replace the fuse with another of the same type and rating.
- Never carry the product from the power cord or any moving part. Always use the hanging/mounting bracket or the handles.
- The maximum ambient temperature (Ta) is 104° F (40° C). Do not operate the product at higher temperatures.
- In the event of a serious operating problem, stop using the product immediately.
- Never try to repair the product. Repairs carried out by unskilled people can lead to damage or malfunction. Please contact the nearest authorized technical assistance center.



Keep this User Manual for future consultation. If you sell the product to another user, be sure that they also receive this document.

2. INTRODUCTION

Product Overview

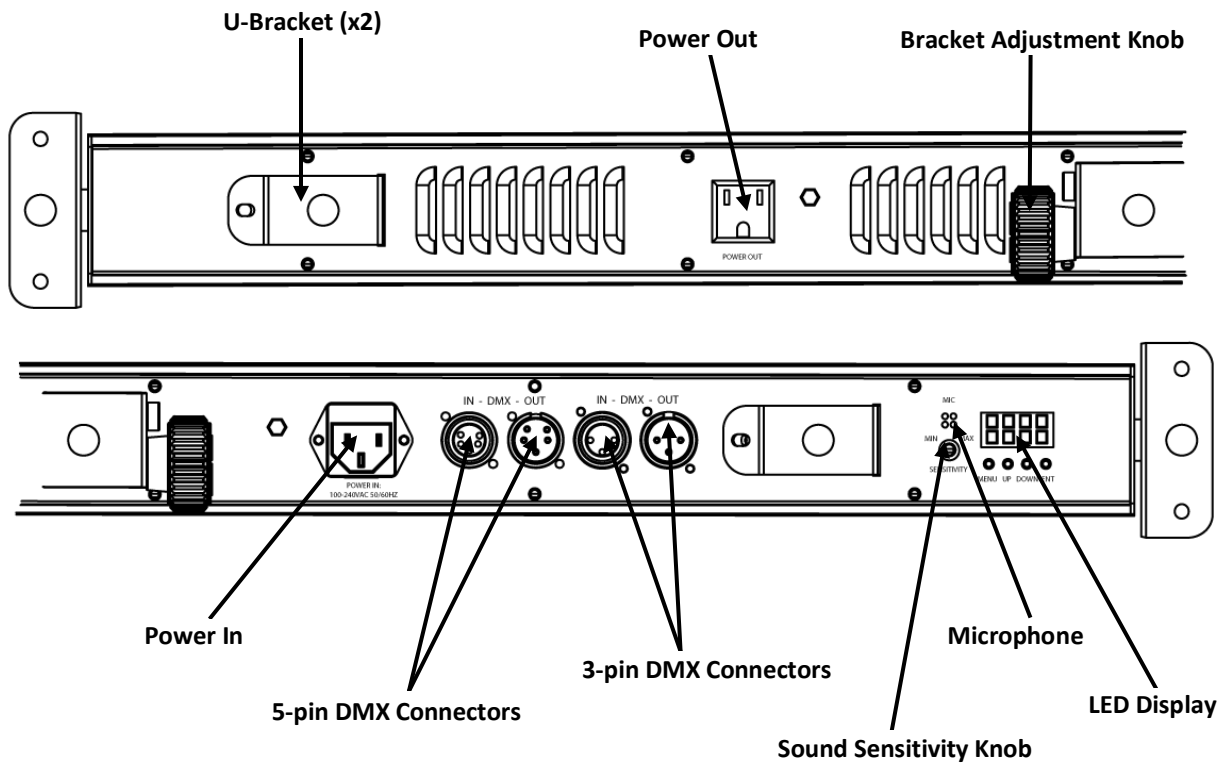

Product Dimensions

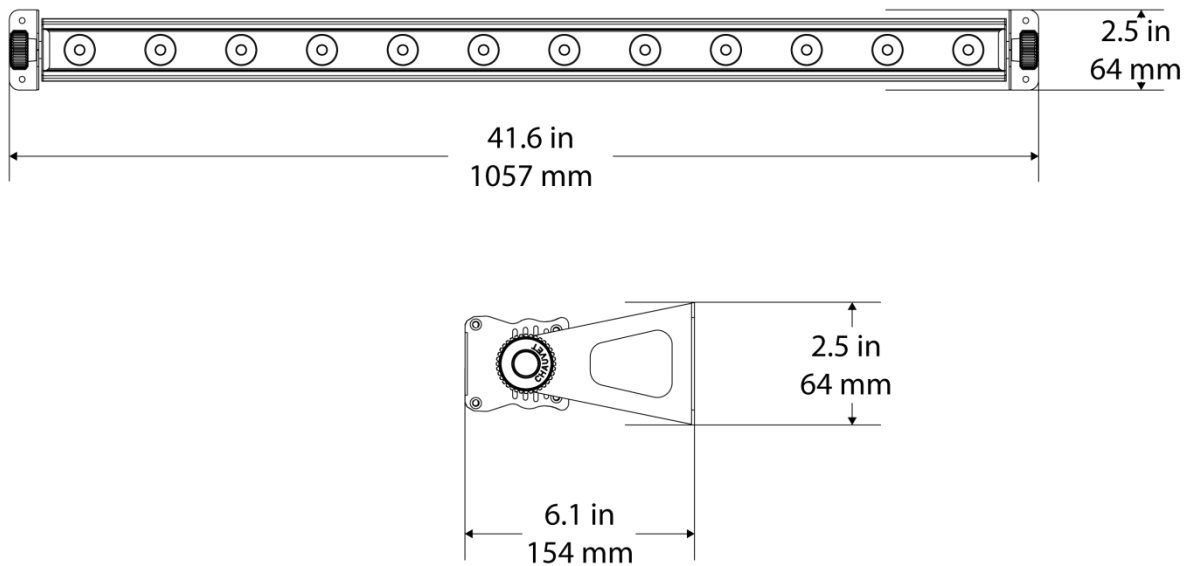

3. SETUP

AC Power The COLORband PiX™ has an auto-ranging power supply and it can work with an input voltage range of 100–240 VAC, 50/60 Hz.

To determine the product's power requirements (circuit breaker, power outlet, and wiring), use the current value listed on the label affixed to the product's back panel, or refer to the product's specifications chart. The listed current rating indicates the product's average current draw under normal conditions.



Always connect the product to a protected circuit (circuit breaker or fuse). Make sure the product has an appropriate electrical ground to avoid the risk of electrocution or fire.



Never connect the product to a rheostat (variable resistor) or dimmer circuit, even if the rheostat or dimmer channel serves only as a 0% to 100% switch.

Fuse Replacement

Follow the instructions below to change the fuse, if necessary.



Disconnect the product from the power outlet before replacing the fuse.

1. Wedge the tip of a flat-head screwdriver into the slot of the fuse holder.
2. Pry the fuse holder out of the housing.
3. Remove the blown fuse from the holder and replace with a fuse of the exact same type and rating.
4. Insert the fuse holder back in place and reconnect power.

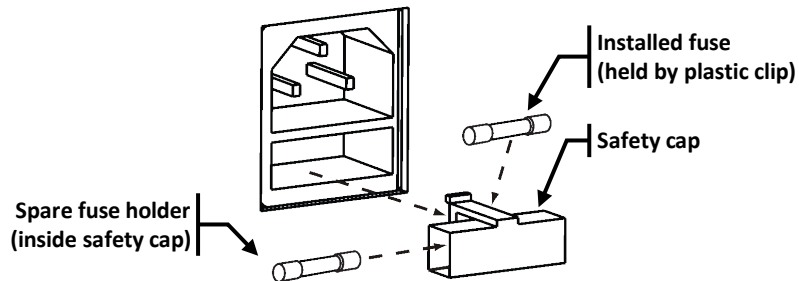

The product does not ship with a spare fuse; however, the safety cap has room for a spare.

Power Linking The product provides power linking via the IEC outlet located in the back of the unit. See the diagram below.

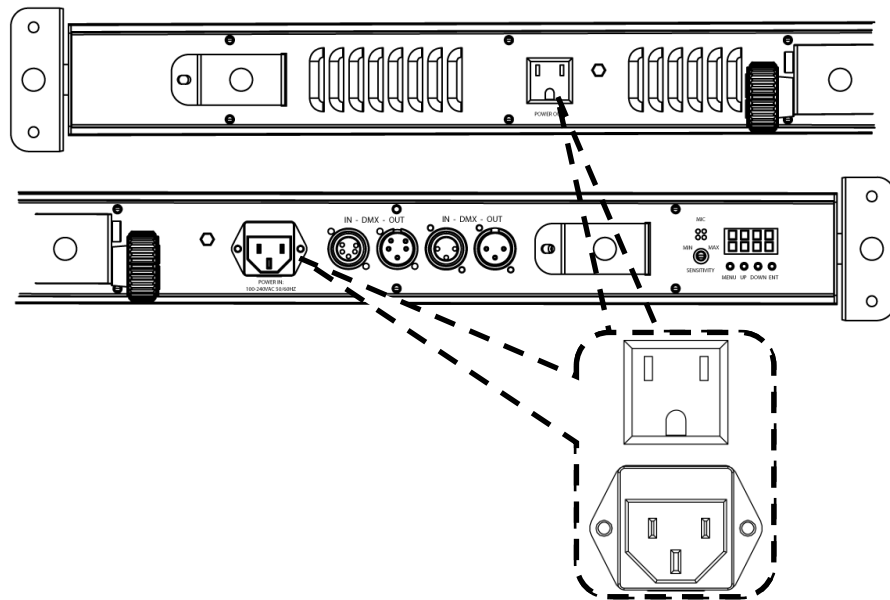

Power Linking Diagram

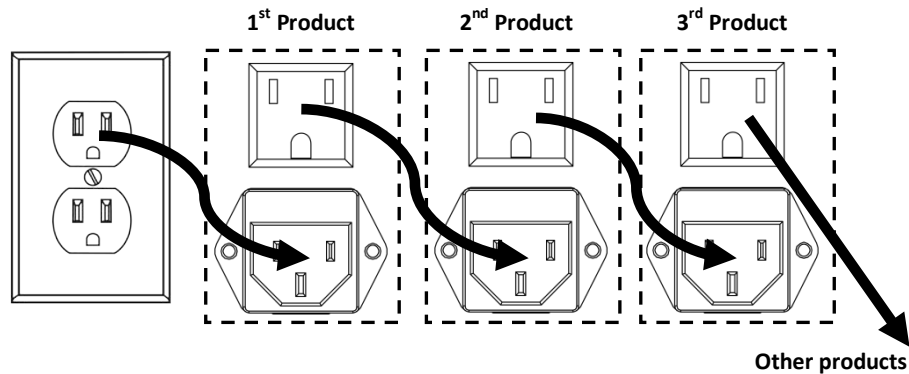

You can power link up to 11 COLORband PiX™ units on 120 VAC or up to 20 COLORband PiX™ units on 230 VAC.



The power-linking diagram shown above corresponds to the North American version of the product ONLY! If using the product in other markets, you must consult with the local CHAUVET® distributor as power linking connectors and requirements may differ in your country or region.

Mounting Before mounting the product, read and follow the safety recommendations indicated in the [Safety Notes](#).

Orientation The COLORband PiX™ may be mounted in any position; however, make sure adequate ventilation is provided around the product.

- Rigging**
- Before deciding on a location for the product, always make sure there is easy access to the product for maintenance and programming purposes.
 - Make sure that the structure or surface onto which you are mounting the product can support the product's weight. Please see the [Technical Specifications](#) section of this manual for weight information.
 - When mounting the product overhead, always use a safety cable. Mount the product securely to a rigging point, whether an elevated platform or a truss.
 - When rigging the product onto a truss, you should use a mounting clamp of appropriate weight capacity. The bracket has a 13-mm hole, which is appropriate for this purpose.
 - When power linking multiple products, you must always consider the length of the power linking cable and mount the products close enough for the cable to reach.
 - The bracket adjustment knobs allow for directional adjustment when aiming the product to the desired angle. Only loosen or tighten the bracket knobs manually. Using tools could damage the knobs.
 - The mounting brackets also serve as floor supports/allow for surface mounting. When mounting the product on the floor, make sure that the product and cables are away from people and vehicles.
 - The CBB-6 bracket (sold separately) is fully compatible with the COLORband PiX™. See following for instructions on usage of the bracket.

Mounting Diagram

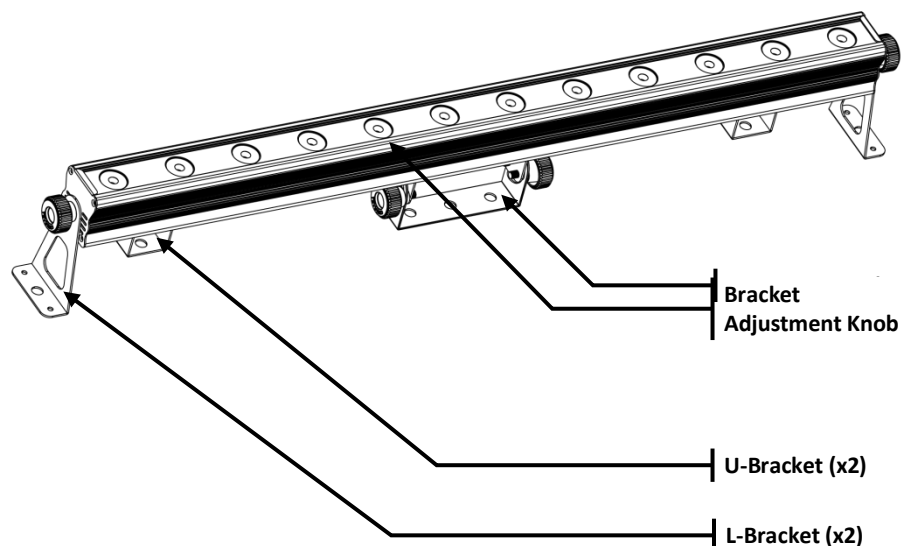

CBB-6 Instructions

The CBB-6 works with the COLORband PiX™ Mini (shown below), COLORband PiX™, and most linear/strip lights.

Basic Assembly

To assemble the CBB-6 bracket:

1. Unscrew the bracket adjustment knob on the light you wish to attach to the bracket.
2. Align the light to any of the small mounting holes on the CBB-6 (maximum 6 lights).
3. Reattach the bracket adjustment knob to the light.
4. Repeat up to a total of six times with a pair of CBB-6 brackets.

The final assembly should appear similar to this:

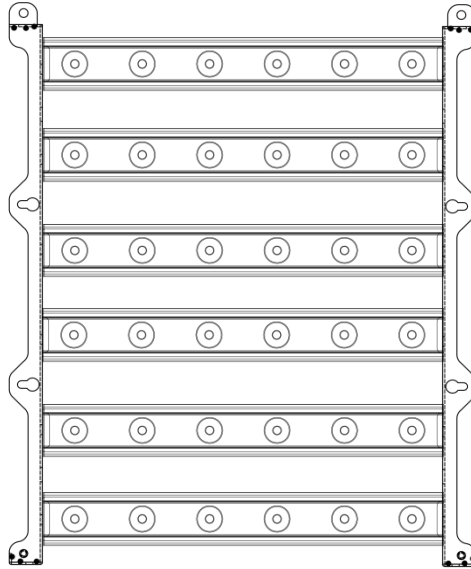

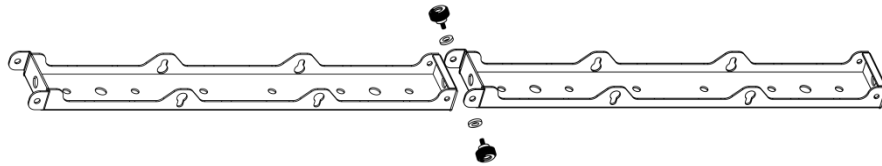

Advanced Assembly Options

The CBB-6 is fully stackable. Use the included screws to attach another CBB-6 to the top of the bracket for additional rows of lights.



 Do NOT connect more than two CBB-6 brackets vertically (for a maximum of 12 strip lights).

 Before mounting the CBB-6 onto any structure, ensure that the structure onto which you are mounting the product on can support the total weight.

 When rigging the product onto truss, you should use a mounting clamp with the appropriate weight capacity. The CBB-6 bracket has multiple 13 mm holes which are appropriate for this purpose.

 CHAUVET® recommends the CLP-15 heavy-duty clamp (sold separately).

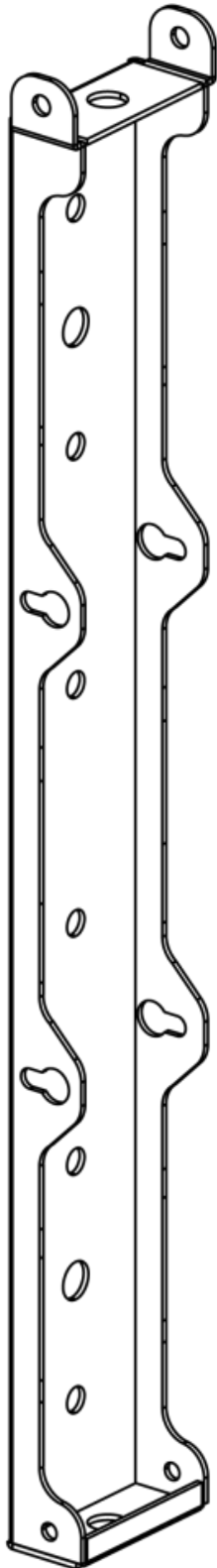

4. OPERATION

Control Panel Operation To access the control panel functions, use the four buttons located underneath the display. Please refer to the [Product Overview](#) to see the button locations on the control panel.

Button	Function
<MENU>	Press to find an operation mode or to back out of the current menu option
<UP>	Press to scroll up the list of options or to find a higher value
<DOWN>	Press to scroll down the list of options or to find a lower value
<ENTER>	Press to activate a menu option or a selected value

Menu Map

Mode	Programming Steps	Description	
Static Colors	C--	C1	Red
		C2	Green
		C3	Blue
		C4	Cyan
		C5	Magenta
		C6	Yellow
		C7	White
Auto Programs	P--	P1	7-Color Switching
		P2	7-Color Fading
		P3	3-Color Switching
		P4	3-Color Fading
		P5	Chase Program
		P6	7-Color Sound Active
		P7	7-Color Sound Active Chase + Strobe
Program Speed	S--	S001-S100	Selects auto program speed
Slave Mode	SLA		Sets Slave Mode
Custom Color Mixing	U--	r--	Red
		g--	Green
		b--	Blue
DMX Personalities	3-CH	d001-d512	Selects DMX starting address
	4-CH		
	6-CH		
	7-CH		
	9-CH		
	12-CH		
	18-CH		
36-CH			

Configuration (DMX)

Set the product in DMX mode to control with a DMX controller.

1. Connect the product to a suitable power outlet.
2. Turn the product on.
3. Connect a DMX cable from the DMX output of the DMX controller to the DMX input socket on the product.

DMX Personalities and Starting Address

The COLORband PiX™ has eight DMX personalities, from a 3-channel mode for basic control to a 36-channel mode with more advanced control over the lights.

The COLORband PiX™ uses up to 36 DMX channels in its 36-channel DMX mode, which defines the highest configurable address to **477**.

When selecting a starting DMX address, always consider the number of DMX channels the selected DMX mode uses. If you choose a starting address that is too high, you could restrict the access to some of the product's channels.

If you are not familiar with the DMX protocol, download the "DMX Primer" from the CHAUVET® website.

To select the DMX personality, do the following:

1. Press **<MENU>** repeatedly until **3-CH**, **4-CH**, **6-CH**, **7-CH**, **9-CH**, **12CH**, **18CH**, or **36CH** shows on the display.
2. Press **<ENTER>** to choose your DMX personality when it appears on the display.

To then choose your starting address:

1. The display should show **d 1** once you've selected your DMX personality using the steps above.
2. Use **<UP>** or **<DOWN>** to select the starting address.
3. Press **<ENTER>**.

Sectional Control

The COLORband PiX™ offers by-section control of the lights, and you can select from two through 12 sections to control. To access this feature, choose the DMX personality as shown above. What each DMX personality controls is shown below.

Note: Not all DMX personalities offer sectional control.

DMX Channel Assignments and Values

7-CH	Channel	Function	Value	Setting
	1	Red	000 ⇔ 255	0~100%
	2	Green	000 ⇔ 255	0~100%
	3	Blue	000 ⇔ 255	0~100%
	4	Color Macros	000 ⇔ 015	No function
			016 ⇔ 255	Color Macros
	5	Speed	000 ⇔ 255	Speed (slow to fast) (when CH.6 is from 032~233)
		Strobe (CH.1-CH.4 only)	000 ⇔ 015	No function
			016 ⇔ 255	0~30 Hz
	6	Auto Programs	000 ⇔ 031	No function
			032 ⇔ 063	Pulse effect 0~100%
			064 ⇔ 095	Pulse effect 100%~0
			096 ⇔ 114	Pulse effect 100%~0~100%
			115 ⇔ 127	Chase program
			128 ⇔ 159	Auto fade transition
			160 ⇔ 191	Auto snap transition (3 colors)
			192 ⇔ 223	Auto snap transition (7 colors)
			224 ⇔ 255	Sound active mode
	7	Dimmer	000 ⇔ 255	0~100%

3-CH	Channel	Function	Value	Setting
	1	Red	000 ⇔ 255	0~100%
	2	Green	000 ⇔ 255	0~100%
	3	Blue	000 ⇔ 255	0~100%

4-CH	Channel	Function	Value	Setting
	1	Red	000 ⇔ 255	0~100%
	2	Green	000 ⇔ 255	0~100%
	3	Blue	000 ⇔ 255	0~100%
	4	Dimmer	000 ⇔ 255	0~100%

6-CH	Channel	Function	Value	Setting	Section
	1	Red	000 ⇔ 255	0~100%	1
	2	Green	000 ⇔ 255	0~100%	
	3	Blue	000 ⇔ 255	0~100%	
	4	Red	000 ⇔ 255	0~100%	2
	5	Green	000 ⇔ 255	0~100%	
	6	Blue	000 ⇔ 255	0~100%	

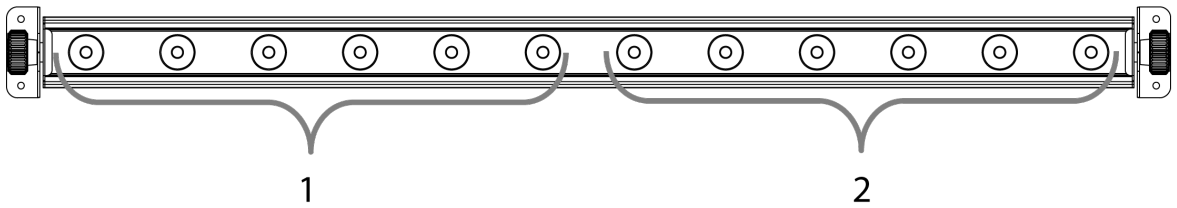

9-CH	Channel	Function	Value	Setting	Section
	1	Red	000 ⇔ 255	0~100%	1
	2	Green	000 ⇔ 255	0~100%	
	3	Blue	000 ⇔ 255	0~100%	
	4	Red	000 ⇔ 255	0~100%	2
	5	Green	000 ⇔ 255	0~100%	
	6	Blue	000 ⇔ 255	0~100%	
	7	Red	000 ⇔ 255	0~100%	3
	8	Green	000 ⇔ 255	0~100%	
	9	Blue	000 ⇔ 255	0~100%	

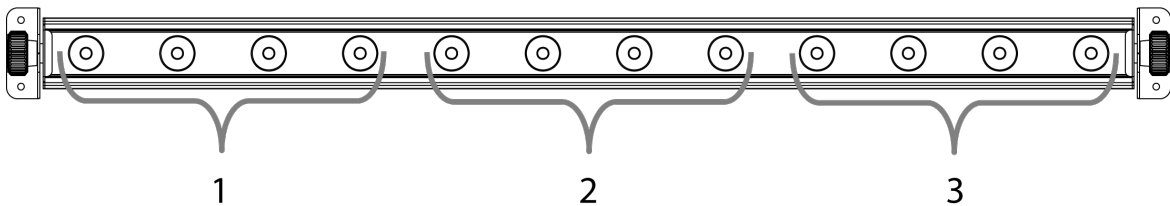

12-CH	Channel	Function	Value	Setting	Section
	1	Red	000 ⇄ 255	0~100%	1
	2	Green	000 ⇄ 255	0~100%	
	3	Blue	000 ⇄ 255	0~100%	
	4	Red	000 ⇄ 255	0~100%	2
	5	Green	000 ⇄ 255	0~100%	
	6	Blue	000 ⇄ 255	0~100%	
	7	Red	000 ⇄ 255	0~100%	3
	8	Green	000 ⇄ 255	0~100%	
	9	Blue	000 ⇄ 255	0~100%	
	10	Red	000 ⇄ 255	0~100%	4
	11	Green	000 ⇄ 255	0~100%	
	12	Blue	000 ⇄ 255	0~100%	

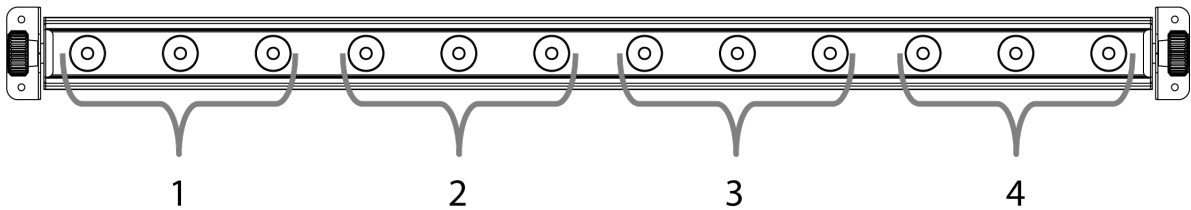

18-CH	Channel	Function	Value	Setting	Section
	1	Red	000 ⇄ 255	0~100%	1
	2	Green	000 ⇄ 255	0~100%	
	3	Blue	000 ⇄ 255	0~100%	
	4	Red	000 ⇄ 255	0~100%	2
	5	Green	000 ⇄ 255	0~100%	
	6	Blue	000 ⇄ 255	0~100%	
	7	Red	000 ⇄ 255	0~100%	3
	8	Green	000 ⇄ 255	0~100%	
	9	Blue	000 ⇄ 255	0~100%	
	10	Red	000 ⇄ 255	0~100%	4
	11	Green	000 ⇄ 255	0~100%	
	12	Blue	000 ⇄ 255	0~100%	
	13	Red	000 ⇄ 255	0~100%	5
	14	Green	000 ⇄ 255	0~100%	
	15	Blue	000 ⇄ 255	0~100%	
	16	Red	000 ⇄ 255	0~100%	6
	17	Green	000 ⇄ 255	0~100%	
	18	Blue	000 ⇄ 255	0~100%	

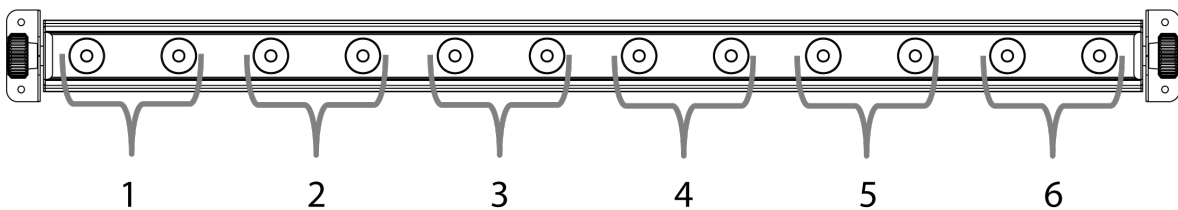

36-CH	Channel	Function	Value	Setting	Section
	1	Red	000 ⇄ 255	0~100%	1
	2	Green	000 ⇄ 255	0~100%	
	3	Blue	000 ⇄ 255	0~100%	
	4	Red	000 ⇄ 255	0~100%	2
	5	Green	000 ⇄ 255	0~100%	
	6	Blue	000 ⇄ 255	0~100%	
	7	Red	000 ⇄ 255	0~100%	3
	8	Green	000 ⇄ 255	0~100%	
	9	Blue	000 ⇄ 255	0~100%	
	10	Red	000 ⇄ 255	0~100%	4
	11	Green	000 ⇄ 255	0~100%	
	12	Blue	000 ⇄ 255	0~100%	
	13	Red	000 ⇄ 255	0~100%	5
	14	Green	000 ⇄ 255	0~100%	
	15	Blue	000 ⇄ 255	0~100%	
	16	Red	000 ⇄ 255	0~100%	6
	17	Green	000 ⇄ 255	0~100%	
	18	Blue	000 ⇄ 255	0~100%	
	19	Red	000 ⇄ 255	0~100%	7
	20	Green	000 ⇄ 255	0~100%	
	21	Blue	000 ⇄ 255	0~100%	
	22	Red	000 ⇄ 255	0~100%	8
	23	Green	000 ⇄ 255	0~100%	
	24	Blue	000 ⇄ 255	0~100%	
	25	Red	000 ⇄ 255	0~100%	9
	26	Green	000 ⇄ 255	0~100%	
	27	Blue	000 ⇄ 255	0~100%	
	28	Red	000 ⇄ 255	0~100%	10
	29	Green	000 ⇄ 255	0~100%	
	30	Blue	000 ⇄ 255	0~100%	
	31	Red	000 ⇄ 255	0~100%	11
	32	Green	000 ⇄ 255	0~100%	
	33	Blue	000 ⇄ 255	0~100%	
	34	Red	000 ⇄ 255	0~100%	12
	35	Green	000 ⇄ 255	0~100%	
	36	Blue	000 ⇄ 255	0~100%	

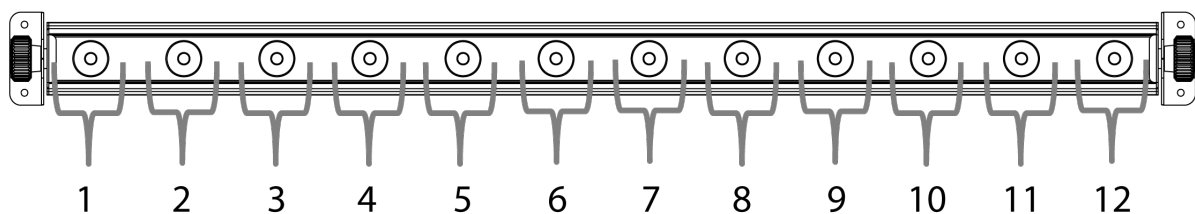

Configuration (Standalone)

Set the product in one of the standalone modes to control without a DMX controller.

1. Connect the product to a suitable power outlet.
2. Turn the product on.



Never connect a product that is operating in any standalone mode (either Static, Automatic, or Sound) to a DMX string connected to a DMX controller. Products in standalone mode may transmit DMX signals that could interfere with the DMX signals from the controller.

Static Color Mode

To enable the Static Color Mode, do the following:

1. Press **<MENU>** repeatedly until **C--** shows on the display.
2. Press **<ENTER>**.
3. Use **<UP>** or **<DOWN>** to choose a color (**C1-C7**).
4. Press **<ENTER>**.

Automatic Mode

To enable the Automatic Mode, follow the instructions below:

1. Press **<MENU>** repeatedly until **P--** shows on the display.
2. Press **<ENTER>**.
3. Use **<UP>** or **<DOWN>** to choose your auto program (**P1-P7**).
4. Press **<ENTER>**.

You can adjust the speed of the automatic program as well.

1. Press **<MENU>** repeatedly until **S--** shows on the display.
2. Press **<ENTER>**.
3. Use **<UP>** or **<DOWN>** to adjust the duration of each step of the automatic program from **S001** (slow) to **S100** (fast).
4. Press **<ENTER>**.

Custom Static Color Mode

To enable the Custom Static Color Mode, follow the instructions below:

1. Press **<MENU>** repeatedly until **U--** shows on the display.
2. Press **<ENTER>**.
3. Press **<UP>** or **<DOWN>** to choose between colors (**r--**, **g--**, **b--**).
4. Press **<ENTER>**.
5. Press **<UP>** or **<DOWN>** to choose the intensity of the color (**000-100**).
6. Repeat the steps to mix additional colors to create the color you need.
7. Press **<ENTER>**.

Master/Slave Mode

The Master/Slave mode allows a single COLORband PiX™ unit (the “master”) to control the actions of one or more COLORband PiX™ units (the “slaves”) without the need of a DMX controller. The master unit will be set to operate in either Automatic or Sound Active mode, while the slave units will be set to operate in Slave Mode. Once set and connected, the slave units will operate in unison with the master unit.

Configure the units as indicated below.

Slave units:

1. Press **<MENU>** repeatedly until **SLA** shows on the display.
2. Press **<ENTER>** to accept.
3. Set the DMX address to **001**.
4. Connect the DMX input of the first slave unit to the DMX output of the master unit.
5. Connect the DMX input of the subsequent slave units to the DMX output of the previous slave unit.
6. Finish setting and connecting all the slave units.

Master unit:

1. Set the master unit to operate in either Automatic or Sound Active mode.
2. Make the master unit the first unit in the DMX daisy chain.



- **Configure all the slave units before connecting the master unit to the DMX daisy chain.**
- **Never connect a DMX controller to a DMX string configured for Master/Slave operation because the controller may interfere with the signals from the master unit.**
- **Do not connect more than 31 slave units to the master unit.**

5. TECHNICAL INFORMATION

Product Maintenance

Dust build-up reduces light output performance and can cause overheating. This can lead to reduction of the light source's life. To maintain optimum performance and minimize wear, you should clean your lighting products at least twice a month. However, be aware that usage and environmental conditions are contributing factors to increasing the cleaning frequency.

To clean the product, follow the instructions below:

- Unplug the product from power.
- Wait until the product is cold.
- Use a vacuum (or dry compressed air) and a soft brush to remove dust collected on the external surface/vents.
- Clean all transparent surfaces with a mild soap solution, ammonia-free glass cleaner, or isopropyl alcohol.
- Apply the solution directly to a soft, lint-free cotton cloth or a lens cleaning tissue.
- Softly drag any dirt or grime to the outside of the transparent surface.
- Gently polish the transparent surfaces until they are free of haze and lint.



Always dry the transparent surfaces carefully after cleaning them.

In case you need to return a product or request support:

- If you live in the U.S., contact CHAUVET® World Headquarters (see below).
- If you live in the UK or Ireland, contact CHAUVET® Europe Ltd. (see below).
- If you live in any other country, DO NOT contact CHAUVET®. Instead, contact your distributor of record. Refer to our website for contact details of distributors outside the U.S., United Kingdom, or Ireland.

Contact Us

World Headquarters

CHAUVET®

General Information

Address: 5200 NW 108th Avenue
Sunrise, FL 33351
Voice: (954) 929-1115
Fax: (954) 929-5560
Toll free: (800) 762-1084

Technical Support

Voice: (954) 929-1115 (Press 4)
Fax: (954) 756-8015
Email: tech@chauvetlighting.com

World Wide Web

www.chauvetlighting.com

United Kingdom & Ireland

CHAUVET® Europe Ltd.

General Information

Address: Unit 1C
Brookhill Road Industrial Estate
Pinxton, Nottingham, UK
NG16 6NT
Voice: +44 (0)1773 511115
Fax: +44 (0)1773 511110

Technical Support

Email: uktech@chauvetlighting.com

World Wide Web

www.chauvetlighting.co.uk



If you live outside the U.S., United Kingdom, or Ireland, contact your distributor of record and follow their instructions on how to return CHAUVET® products to them. Visit our website for contact details.

Returns

Call the corresponding CHAUVET® Tech Support office and request a Return Merchandise Authorization (RMA) number before shipping the product. Be prepared to provide the model number, serial number, and a brief description of the cause for the return.

You must send the merchandise prepaid, in its original box, and with its original packing and accessories. CHAUVET® will not issue call tags.

Clearly label the package with the RMA number. CHAUVET® will refuse any product returned without an RMA number.



Write the RMA number on a properly affixed label. DO NOT write the RMA number directly on the box.

Before sending the product, clearly write the following information on a piece of paper and place it inside the box:

- Your name
- Your address
- Your phone number
- The RMA number
- A brief description of the problem

Be sure to pack the product properly. Any shipping damage resulting from inadequate packaging will be your responsibility. As a suggestion, proper FedEx packing or double-boxing are recommended shipping methods.



CHAUVET® reserves the right to use its own discretion to repair or replace returned product(s).

6. TECHNICAL SPECIFICATIONS

Dimensions and Weight	Length	Width	Height	Weight
	41.6 in (1,057 mm)	6.1 in (154 mm)	2.5 in (64 mm)	8.9 lbs (4 kg)
Note: Dimensions in inches rounded to the nearest decimal digit.				
Power	Power Supply Type	Range		Voltage Selection
	Switching (internal)	100~240 V, 50/60 Hz		Auto-ranging
	Parameter	120 V, 60 Hz		230 V, 50 Hz
	Consumption	82 W		86 W
	Operating	0.7 A		0.4 A
	Power linking current (units)	8 A (11 units)		8 A (20 units)
	Fuse	F 2 A, 250 V		F 2 A, 250 V
	Power I/O	US/Worldwide		UK/Europe
	Power input connector	IEC		IEC
	Power output connector	Edison		IEC
Power Cord plug	Edison (U.S.)		Local plug	
Light Source	Type	Power	Lifespan	
	LED	3 W	50,000 hours	
	Color	Quantity	Current	
	Tri-color	12	350 mA	
Photo Optic	Parameter			
	Strobe Rate	0-30 Hz		
	Illuminance @ 2 m	1,947 lux		
	Beam angle	19°		
	Field angle	35°		
Thermal	Maximum External Temp.	Cooling System		
	104° F (40° C)	Convection		
DMX	I/O Connectors	Connector Type	Channel Range	
	3-pin and 5-pin XLR	Sockets	3, 4, 6, 7, 9, 12, 18, 36	
Ordering	Product Name	Item Code	Item Number	
	COLORband PiX™	03020469	COLORBANDPIX	

