

# COLORrail™ IRC IP

## User Manual

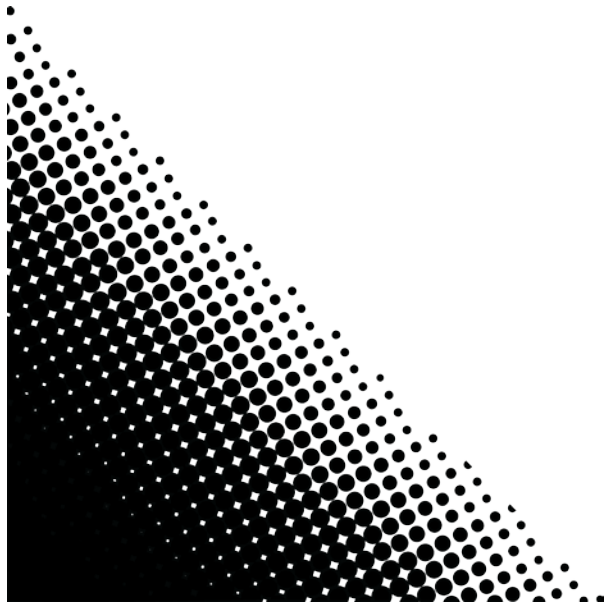
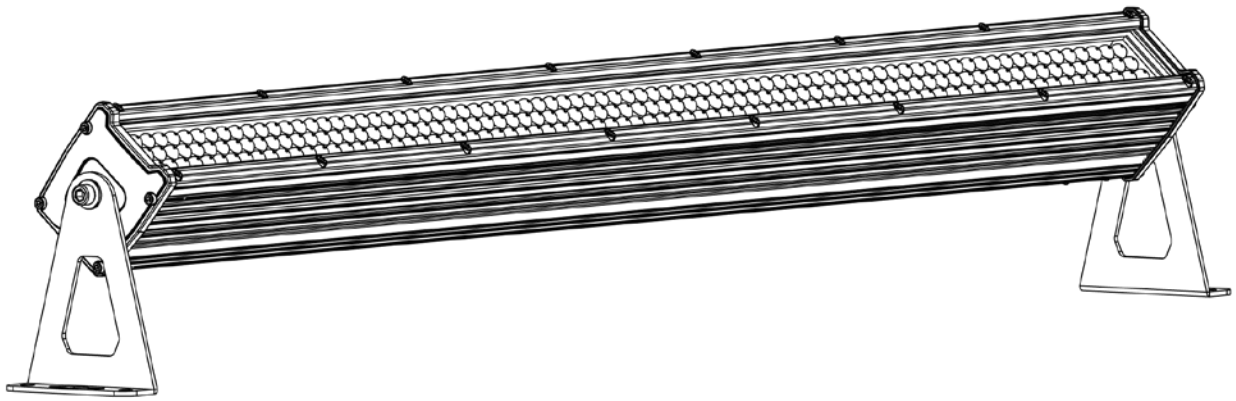

---

# TABLE OF CONTENTS

<b>1. Before You Begin</b> .....	<b>3</b>
What Is Included .....	3
Unpacking Instructions .....	3
Claims.....	3
Text Conventions .....	3
Icons.....	3
Disclaimer .....	3
Product at a Glance .....	4
Safety Notes.....	4
<b>2. Introduction</b> .....	<b>5</b>
Product Overview .....	5
Product Dimensions .....	5
<b>3. Setup</b> .....	<b>6</b>
AC Power .....	6
Power Linking .....	6
Mounting .....	7
Orientation .....	7
Rigging .....	7
<b>4. Operation</b> .....	<b>8</b>
Control Panel Operation.....	8
Menu Map .....	8
Configuration (Standalone) .....	9
Auto Run Mode.....	9
Auto Programs.....	9
Master/Slave Mode.....	10
Infrared Control.....	11
IRC-6 (Infrared Remote Control 6) Operation.....	11
Configuration (DMX) .....	12
DMX Personalities and Starting Address.....	12
DMX Channel Assignments and Values .....	12
2-c.....	12
3-c.....	12
4-c.....	13
7-c.....	13
14c.....	13
COLORrail™ IRC IP Zones for DMX Control (14c) .....	13
26c.....	14
COLORrail™ IRC IP Zones for DMX Control (26c) .....	14
<b>5. Technical Information</b> .....	<b>15</b>
Product Maintenance .....	15
<b>6. Technical Specifications</b> .....	<b>16</b>
<b>Returns</b> .....	<b>17</b>
<b>Contact Us</b> .....	<b>18</b>

# 1. BEFORE YOU BEGIN

## What Is Included

- COLORrail™ IRC IP
- Power Cord
- DMX In Adapter
- DMX Out Adapter
- 2 Hanging Brackets with Mounting Hardware (L-brackets)
- Warranty Card
- Quick Reference Guide

## Unpacking Instructions

Immediately upon receipt, carefully unpack the product and check the box to make sure you have received all the parts indicated above in good condition.

## Claims



If the box or the contents (the product and included accessories) appear damaged from shipping, or show signs of mishandling, upon receipt notify the carrier immediately, not Chauvet. Failure to do so in a timely manner may invalidate your claim with the carrier. In addition, keep the container and all the packing material for inspection.

For other issues such as missing components or parts, damage not related to shipping, or concealed damage, file a claim with Chauvet within 7 days of receiving the merchandise.

## Text Conventions

Convention	Meaning
<b>1–512</b>	A range of values
<b>50/60</b>	A set of values of which only one can be chosen
<b>Settings</b>	A menu option not to be modified
<b>Menu &gt; Settings</b>	A sequence of menu options to be followed
<b>&lt;UP&gt;</b>	A key to be pressed on the product's control panel
<b>ON</b>	A value to be entered or selected

## Icons

Icon	Meaning
	Critical installation, configuration, or operation information. Failure to comply with this information may render the product partially or completely inoperative, cause damage to the product, or cause harm to the user.
	Important installation or configuration information. Failure to comply with this information may prevent the product from functioning correctly.
	Useful information.

## Disclaimer

The information and specifications contained in this document are subject to change without notice. Chauvet assumes no responsibility or liability for any errors or omissions that may appear in this manual. Chauvet reserves the right to update the existing document or to create a new document to correct any errors or omissions.

You can download the latest version of this document from [www.chauvetlighting.com](http://www.chauvetlighting.com).

© Copyright 2015 Chauvet. All rights reserved.

Electronically published by Chauvet in the United States of America.

Author	Date	Editor	Date
M. Trouard	05/06/15	R. Isenstadt	05/07/15

## Product at a Glance

Use on Dimmer	X	Auto Programs	P
Outdoor Use	P	Auto-ranging Power Supply	P
Sound-Activated	X	Replaceable Fuse	X
DMX	P	User-Serviceable	X
Master/Slave	P		

## Safety Notes

Please read the following Safety Notes carefully before working with the product. The Notes include important safety information about installation, usage, and maintenance.



- Always connect the product to a GFI (ground fault interrupter) circuit to avoid the risk of electrocution.
- To eliminate wear and improve its lifespan, during periods of non-use completely disconnect from power via breaker or by unplugging it.
- Always disconnect the product from the power source before cleaning.
- Avoid direct eye exposure to the light source while the product is on.
- Make sure the power cord is not crimped or damaged.
- Never disconnect the product from power cord by pulling or tugging on the cord.
- If mounting the product overhead, always secure to a fastening device using a safety cable.
- Make sure there are no flammable materials close to the product when operating.
- Do not touch the product's housing when operating because it may be very hot.



- Always make sure that the voltage of the outlet to which you are connecting the product is within the range stated on the decal or rear panel of the product.
- This product is for indoor or temporary outdoor use (IP65). Do not expose to harsh or excessively corrosive environmental conditions (whether indoors or outdoors), including, but not limited to, extreme temperatures, humidity, atmospheric conditions (including salinity or pressure), radiation (UV, infrared or nuclear), shock and conditions which exceed the product's Ingress Protection ("IP") rating. Do not submerge this product.
- Always install the product in a location with adequate ventilation, at least 20 in (50 cm) from adjacent surfaces.
- Never connect the product to a dimmer.
- Never carry the product from the power cord or any moving part. Always use the hanging/mounting bracket or the handles.
- The maximum ambient temperature (Ta) is 113 °F (45 °C). Do not operate the product at higher temperatures.
- In the event of a serious operating problem, stop using the product immediately.
- Never try to repair the product. Repairs carried out by unskilled people can lead to damage or malfunction. Please contact the nearest authorized technical assistance center.



Keep this User Manual for future consultation. If you sell the product to another user, be sure that they also receive this document.

## 2. INTRODUCTION

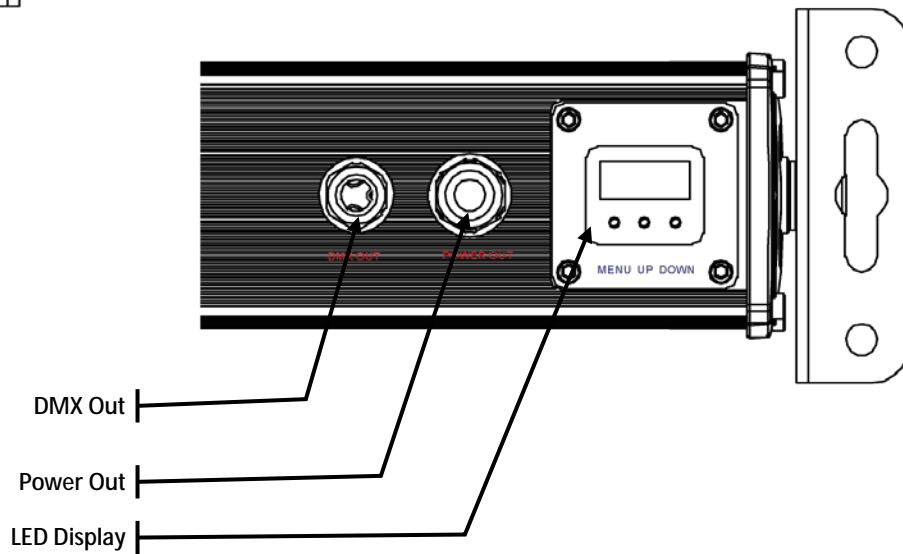
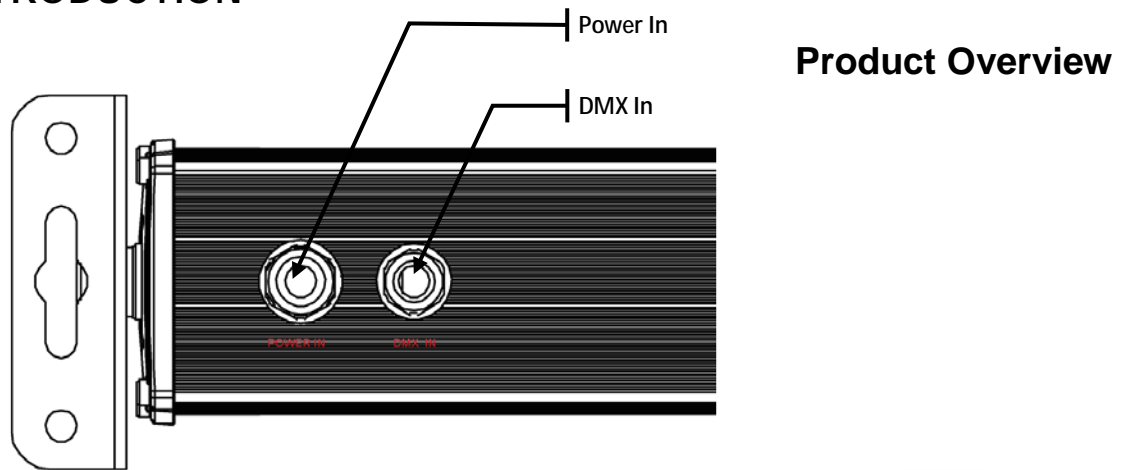

## Product Dimensions

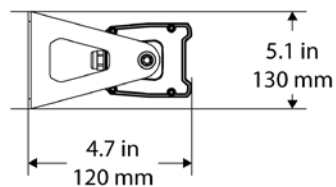
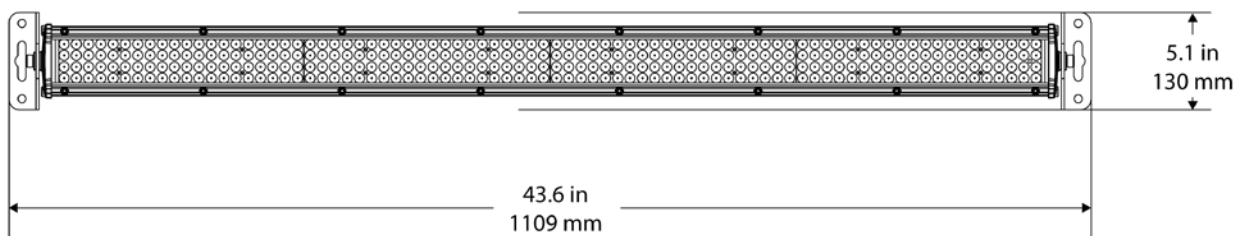

---

## 3. SETUP

**AC Power** The COLORrail™ IRC IP has an auto-ranging power supply and it can work with an input voltage range of 100–240 VAC, 50/60 Hz.

To determine the product's power requirements (circuit breaker, power outlet, and wiring), use the current value listed on the label affixed to the product's back panel, or refer to the product's specifications chart. The listed current rating indicates the product's average current draw under normal conditions.



- **Always connect the product to a GFI protected circuit (circuit breaker or fuse). Make sure the product has an appropriate electrical ground to avoid the risk of electrocution or fire.**
- **To eliminate wear and improve its lifespan, during periods of non-use completely disconnect from power via breaker or by unplugging it.**



**Never connect the product to a rheostat (variable resistor) or dimmer circuit, even if the rheostat or dimmer channel serves only as a 0 to 100% switch.**

**Power Linking** The product provides a power linking option via the pigtails located on the back of the unit.

You can daisy chain up to 15 units on 120 VAC or up to 28 units on 230 VAC.

If you choose not to use the power linking feature, be sure to use the included screw on cap to prevent any water from getting into the power cords.



**The power linking described above corresponds to the North American version of the product ONLY! If using the product in other markets, you must consult with the local Chauvet distributor as power linking connectors and requirements may differ in your country or region.**

---

**Mounting** Before mounting the product, read and follow the safety recommendations indicated in the [Safety Notes](#).

**Orientation** The COLORrail™ IRC IP may be mounted in any position; however, make sure adequate ventilation is provided around the product.

- Rigging**
- Before deciding on a location for the product, always make sure there is easy access to the product for maintenance and programming purposes.
  - Make sure that the structure or surface onto which you are mounting the product can support the product's weight. Please see the [Technical Specifications](#) section of this manual for weight information.
  - When mounting the product overhead, always use a safety cable. Mount the product securely to a rigging point, whether an elevated platform or a truss.
  - When rigging the product onto a truss, you should use a mounting clamp of appropriate weight capacity. Each L-bracket has holes, which are appropriate for this purpose.
  - When power linking multiple products, you must always consider the length of the power linking cable and mount the products close enough for the cable to reach.
  - The bracket adjustment knobs allow for directional adjustment when aiming the product to the desired angle. Only loosen or tighten the bracket knobs manually. Using tools could damage the knobs.
  - This product is for indoor or outdoor use (IP65). Do not expose to harsh or excessively corrosive environmental conditions (whether indoors or outdoors), including, but not limited to, extreme temperatures, humidity, atmospheric conditions (including salinity or pressure), radiation (UV, infrared or nuclear), shock and conditions which exceed the product's Ingress Protection ("IP") rating. Do not submerge this product.

**Mounting Diagram**

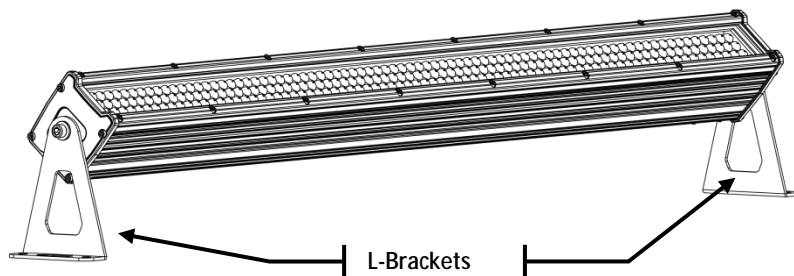

# 4. OPERATION

## Control Panel Operation

To access the control panel functions, use the three buttons located underneath the display.

**Note: The <MENU> button has two selection modes.**

Button	Function
<MENU>	<ul style="list-style-type: none"> <li>Long Press to scroll through the modes, and to back out of the Programming Steps</li> <li>Short press to enter Programming Steps</li> </ul>
<UP>	To scroll up the list of options or values in Programming Steps
<DOWN>	To scroll down the list of options or values in Programming Steps



**After the COLORrail™ IRC IP is configured, the display will show the last item configured.**

## Menu Map

Mode	Programming Steps		Description	
Auto Run	AUR	nXX	01–99, FL Number of loops	
		S. _	01–99, FL Run speed (slow to fast)	
		F. _	00–99 Strobe speed (slow to fast)	
DMX Address and Personalities	XXX	001–512	DMX address	
	XXc	2-c	DMX personalities	
		3-c		
		4-c		
		7-c		
		14c		
26c				
Slave Mode	SLA		Slave mode	
IR Controller	ir-		Infrared mode (IRC-6)	
Auto Programs	P.01	1.-r	Red	
		2.r9	Yellow	
		3.-9	Green	
		4.9b	Cyan	
		5.-b	Blue	
		6.rb	Magenta	
		7.FL	White	
		8.OF	Off	
		F.01–F.99	Strobe speed (slow to fast)	
	P.02–P.20	S.01–S.99, S.FL	Run speed (slow to fast)	
		F.00–F.99	Strobe speed (slow to fast)	
	P.21–P.22	S.01–S.99, S.FL	Run speed (slow to fast)	
			F.00–F.99	
		Foreground Color	1.-r	Red
			1.r9	Yellow
			1.-9	Green
			1.9b	Cyan
			1.-b	Blue
			1.rb	Magenta
1.FL			White	
1.FF			Off	
Background Color		2.-r	Red	
		2.r9	Yellow	
		2.-9	Green	
		2.9b	Cyan	
		2.-b	Blue	
		2.rb	Magenta	
		2.FL	White	
	2.FF	Off		



---

## Configuration (Standalone)

Set the product in one of the standalone modes to control it without a DMX controller.

- Connect the product to a suitable power outlet.



**Never connect a product that is operating in any standalone mode to a DMX string connected to a DMX controller. Products in standalone mode may transmit DMX signals that could interfere with the DMX signals from the controller.**



**There is no <ENTER> button. After the COLORrail™ IRC IP is configured the display will show the last item configured.**

## Auto Run Mode

To enable the Auto Run mode, follow the instructions below:

1. Press <MENU> with long presses repeatedly until **AUR** shows on the display.
2. Press <MENU> with a short press. The display shows **nXX**.
3. Use <UP> or <DOWN> to select the number of runs through the auto run loop.
4. Press <MENU> with a short press. The display shows **S.XX**.
5. Use <UP> or <DOWN> to select the speed of the auto run loop.
6. Press <MENU> with a short press. The display shows **F.XX**.
7. Use <UP> or <DOWN> to select the strobe speed of the auto run loop.

## Auto Programs

To enable the Auto Program mode, follow the instructions below:

1. Press <MENU> with long presses repeatedly until **P.XX** shows on the display.
2. Use <UP> or <DOWN> to select an auto programs.
3. Press <MENU> with a short press. The display will show the sub-menus options for that Auto Program. See [Menu Map](#).
4. Press <MENU> with a short press repeatedly until the display shows the sub-menu options to be configured.
5. Use <UP> or <DOWN> to select the options within the sub-menu.

---

## Master/Slave Mode

The Master/Slave mode allows a single COLORrail™ IRC IP unit (the master) to control the actions of one or more COLORrail™ IRC IP units (the slaves) without the need of a DMX controller. The master unit will be set to operate in any standalone mode, while the slave units will be set to operate in Slave mode. Once set and connected, the slave units will operate in unison with the master unit.

To enable Master/Slave mode, do the following:

### Slave units:

1. Press **<MENU>** with long presses repeatedly until **SLA** shows on the display.
2. Set the DMX address to **001**. See [DMX Personalities and Starting Address](#).
3. Connect the DMX input of the first slave unit to the DMX output of the master unit.
4. Connect the DMX input of the subsequent slave units to the DMX output of the previous slave unit.
5. Finish setting and connecting all the slave units.

### Master unit:

1. Set the master unit to operate in any standalone mode.
  2. Make the master unit the first unit in the daisy chain.
- **Configure all the slave units before connecting the master unit to the daisy chain.**
  - **Never connect a DMX controller to a DMX string configured for Master/Slave operation because the controller may interfere with the signals from the master unit.**
  - **Do not connect more than 31 slave units to the master unit.**



There is no **<ENTER>** button. After the COLORrail™ IRC IP is configured the display will show the last item configured.

## Infrared Control

The COLORrail™ IRC IP is fully compatible with the IRC-6 infrared remote control from Chauvet DJ (sold separately). To enable the infrared functionality with the COLORrail™ IRC IP, follow the instructions below:

- Press <MENU> repeatedly until ir- shows on the display.

## IRC-6 (Infrared Remote Control 6) Operation

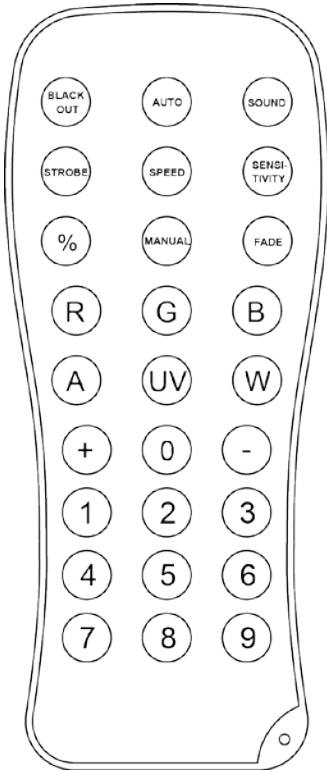

**Note: Make sure to point the IRC-6 directly at the receiver on the product.**

### Automatic Mode

Automatic mode will enable you to run the automatic programs on the product.

To turn on Automatic mode:

1. Press <AUTO> on the IRC-6.
2. Press <+> or <-> to choose between the different auto programs.

To adjust the speed of the automatic program:

1. Press <SPEED> on the IRC-6.
2. Press <%>.
3. Press <+> or <-> to either increase or decrease the speed of the program.

### Manual Color Control

To choose a specific color with the IRC-6:

1. Press <MANUAL> on the IRC-6.
2. Press any number between <0> and <9> to choose your color.

To manually control the RGB percentage:

1. Press <MANUAL> on the IRC-6.
2. Press <R>, <G>, <B>, (red, green, blue) to choose your color.
3. Press <+> or <-> to increase or decrease the percentage of each color.

### Strobe

To adjust the strobe rate of any program that has a strobe function:

1. Press <STROBE> on the IRC-6.
2. Press <+> or <-> to increase or decrease the strobe rate.
3. Press <STROBE> again to turn off the strobe.

**Note: Strobe will only work on the Auto programs that include a strobe option.**

### Blackout

Pressing <BLACK OUT> on the IRC-6 turns off all the lights until the button is pressed again.

**Note:** The IRC-6 will not respond to any inputs when Black Out is activated. If the remote does not respond when a button is pressed, try pressing <BLACK OUT>. You may have inadvertently activated Black Out.

## Configuration (DMX)

Set the product in DMX mode to control with a DMX controller.

1. Connect the product to a suitable power outlet.
2. Connect a DMX cable from the DMX output of the DMX controller to the DMX input socket on the product.

## DMX Personalities and Starting Address

The COLORrail™ IRC IP has a total of six DMX personalities, ranging from a 2-channel mode for basic control to a 26-channel mode with more advanced control over the lights.

The COLORrail™ IRC IP uses up to 26 DMX channels in its 26-channel DMX mode, which defines the highest configurable address to **487**.

When selecting a starting DMX address, always consider the number of DMX channels the selected DMX mode uses. If you choose a starting address that is too high, you could restrict the access to some of the product's channels.

If you are not familiar with the DMX protocol, you may refer to the DMX Primer at [www.chauvetlighting.com](http://www.chauvetlighting.com).

To select the DMX personality, do the following:

1. Press **<MENU>** repeatedly until **XXc** shows on the display.
2. Press **<UP>** or **<DOWN>** repeatedly until the desired DMX personality shows in the display.
3. Press **<MENU>**. The DMX personality no longer shows in the display. The DMX personality is selected

To select a starting address, do the following:

1. Press **<MENU>** repeatedly until three digits (**XXX**) shows on the display. The display will be blinking.
2. Press **<UP>** or **<DOWN>** repeatedly until the desired address shows in the display. The display continues to blink, but the address is selected.



There is no **<ENTER>** button. After the COLORrail™ IRC IP is configured the display will show the last item configured.

## DMX Channel Assignments and Values

2-c	Channel	Function	Value	Setting
1	Color Macros		000 ○ 008	No function
			009 ○ 017	Red
			018 ○ 026	Yellow
			027 ○ 035	Green
			036 ○ 044	Cyan
			045 ○ 053	Blue
			054 ○ 062	Magenta
			063 ○ 071	White
			072 ○ 242	Auto Programs
			243 ○ 255	Reserved
2	Auto Program Speed		000 ○ 255	Slow to fast (when Ch. 1 is 072–255)
3-c	Channel	Function	Value	Setting
1	Red		000 ○ 255	0–100%
2	Green		000 ○ 255	0–100%
3	Blue		000 ○ 255	0–100%

4-c	Channel	Function	Value	Setting
	1	Master Dimmer	000 ó 255	0-100%
	2	Red	000 ó 255	0-100%
	3	Green	000 ó 255	0-100%
	4	Blue	000 ó 255	0-100%

7-c	Channel	Function	Value	Setting
	1	Master Dimmer	000 ó 255	0-100%
	2	Red	000 ó 255	0-100%
	3	Green	000 ó 255	0-100%
	4	Blue	000 ó 255	0-100%
	5	Color Macros	000 ó 008	No function
			009 ó 017	Red
			018 ó 026	Yellow
			027 ó 035	Green
			036 ó 044	Cyan
			045 ó 053	Blue
			054 ó 062	Magenta
			063 ó 071	White
	072 ó 255	Auto Programs		
	6	Auto Program Speed	000 ó 255	Program speed slow to fast (when Ch. 5 is 072-255)
	7	Strobe	000 ó 255	Slow to fast

14c	Channel	Function	Value	Setting
	1	Master Dimmer	000 ó 255	0-100%
	2	Red	000 ó 255	Section 1
	3	Green	000 ó 255	
	4	Blue	000 ó 255	
	5	Red	000 ó 255	
	6	Green	000 ó 255	Section 2
	7	Blue	000 ó 255	
	8	Red	000 ó 255	Section 3
	9	Green	000 ó 255	
	10	Blue	000 ó 255	
	11	Red	000 ó 255	Section 4
	12	Green	000 ó 255	
	13	Blue	000 ó 255	
	14	Strobe	000 ó 255	Slow to fast

**COLORrail™ IRC IP Zones for DMX Control (14c)**

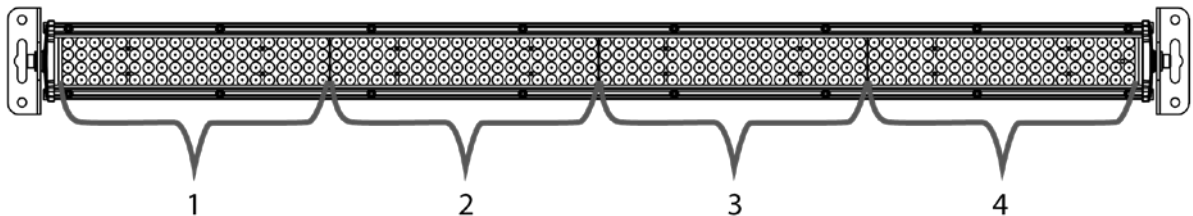

26c	Channel	Function	Value	Setting
	1	Master Dimmer	000 ó 255	0-100%
	2	Red	000 ó 255	0-100%
	3	Green	000 ó 255	0-100%
	4	Blue	000 ó 255	0-100%
	5	Red	000 ó 255	0-100%
	6	Green	000 ó 255	0-100%
	7	Blue	000 ó 255	0-100%
	8	Red	000 ó 255	0-100%
	9	Green	000 ó 255	0-100%
	10	Blue	000 ó 255	0-100%
	11	Red	000 ó 255	0-100%
	12	Green	000 ó 255	0-100%
	13	Blue	000 ó 255	0-100%
	14	Red	000 ó 255	0-100%
	15	Green	000 ó 255	0-100%
	16	Blue	000 ó 255	0-100%
	17	Red	000 ó 255	0-100%
	18	Green	000 ó 255	0-100%
	19	Blue	000 ó 255	0-100%
	20	Red	000 ó 255	0-100%
	21	Green	000 ó 255	0-100%
	22	Blue	000 ó 255	0-100%
	23	Red	000 ó 255	0-100%
	24	Green	000 ó 255	0-100%
	25	Blue	000 ó 255	0-100%
	26	Strobe	000 ó 255	Slow to fast

**COLORrail™ IRC IP Zones for DMX Control (26c)**

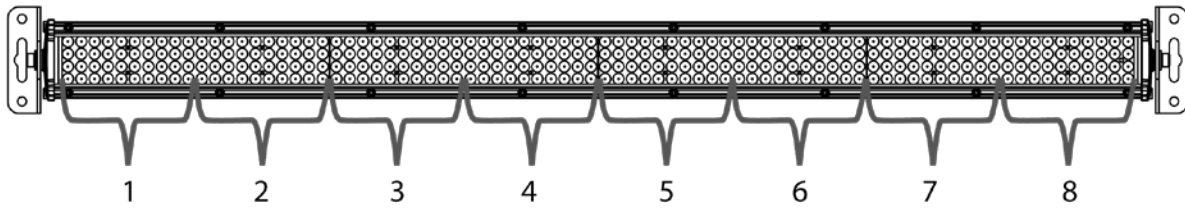

---

## 5. TECHNICAL INFORMATION

### **Product Maintenance**

Dust build-up reduces light output performance and can cause overheating. This can lead to reduction of the light source's life. To maintain optimum performance and minimize wear, you should clean your lighting products at least twice a month. However, be aware that usage and environmental conditions could be contributing factors to increase the cleaning frequency.

To clean the product, follow the instructions below:

1. Unplug the product from power.
2. Wait until the product is at room temperature.
3. Use a vacuum (or dry compressed air) and a soft brush to remove dust collected on the external surface/vents.
4. Clean all external optics and glass/transparent surfaces with a mild soap solution, ammonia-free glass cleaner, or isopropyl alcohol.
5. Apply the solution directly to a soft, lint free cotton cloth or a lens cleaning tissue.
6. Softly drag any dirt or grime to the outside of the external optics or glass/transparent surface.
7. Gently polish the external optics and glass/transparent surfaces until they are free of haze and lint



**Always dry the external optics and glass/transparent surfaces carefully after cleaning them.**

## 6. TECHNICAL SPECIFICATIONS

<b>Dimensions and Weight</b>	<b>Length</b>	<b>Width</b>	<b>Height</b>	<b>Weight</b>
	43.6 in (1,109 mm)	4.7 in (120 mm)	5.1 in (130 mm)	12.4 lb (5.6 kg)
<b>Note:</b> Dimensions in inches rounded to the nearest decimal digit.				
<b>Power</b>	<b>Power Supply Type</b>	<b>Range</b>	<b>Voltage Selection</b>	
	Switching (internal)	100–240 VAC, 50/60 Hz	Auto-ranging	
	<b>Parameter</b>	<b>120 V, 60 Hz</b>	<b>230 V, 50 Hz</b>	
	Consumption	60 W	65 W	
	Operating	0.5 A	0.3 A	
	Power linking current (units)	8 A (15 units)	8 A (28 units)	
<b>Power I/O</b>	<b>Power I/O</b>	<b>US/Canada</b>	<b>UK/Worldwide</b>	
	Power input connector	Proprietary	Proprietary	
	Power output connector	Proprietary	Proprietary	
	Power Cord plug	Edison (US)	Local plug	
<b>Light Source</b>	<b>Type</b>	<b>Lifespan</b>		
	LED	100,000 hours		
	<b>Color</b>	<b>Quantity</b>		
	Red	128		
	Green	96		
	Blue	96		
<b>Photometrics</b>	<b>Parameter</b>			
	Illuminance @ 2 m	1,140 lux		
	Beam angle	28° x 12°		
	Field angle	40° x 21°		
<b>Thermal</b>	<b>Maximum External Temp.</b>	<b>Minimum Startup Temp.</b>	<b>Cooling System</b>	
	113 °F (45 °C)	-4 °F (-20 °C)	Convection	
<b>DMX</b>	<b>I/O Connectors</b>	<b>Connector Type</b>	<b>Channel Range</b>	
	3-pin XLR	Proprietary	2, 3, 4, 7, 14 or 26	
<b>Ordering</b>	<b>Product Name</b>	<b>Item Code</b>	<b>UPC Number</b>	
	COLORrail™ IRC IP	03030121	781462206482	

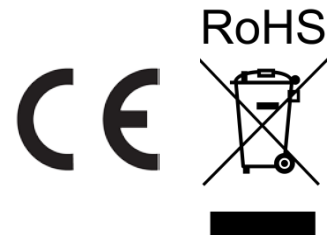



---

# RETURNS

In case you need to get support or return a product:

- If you are located in the U.S., contact Chauvet World Headquarters.
- If you are located in the UK or Ireland, contact Chauvet Europe Ltd.
- If you are located in Mexico, contact Chauvet Mexico.
- If you are located in Benelux, contact Chauvet Europe BVBA.
- If you are located in any other country, DO NOT contact Chauvet. Instead, contact your local distributor. See [www.chauvetlighting.com](http://www.chauvetlighting.com) for distributors outside the U.S., UK, Ireland, Mexico, or Benelux.



**If you are located outside the U.S., UK, Ireland, Mexico, or Benelux, contact your distributor of record and follow their instructions on how to return Chauvet products to them. Visit our website [www.chauvetlighting.com](http://www.chauvetlighting.com) for contact details.**

Call the corresponding Chauvet Technical Support office and request a Return Merchandise Authorization (RMA) number before shipping the product. Be prepared to provide the model number, serial number, and a brief description of the cause for the return.

You must send the merchandise prepaid, in its original box, and with its original packing and accessories. Chauvet will not issue call tags.

Clearly label the package with the RMA number. Chauvet will refuse any product returned without an RMA number.



**Write the RMA number on a properly affixed label. DO NOT write the RMA number directly on the box.**

Before sending the product, clearly write the following information on a piece of paper and place it inside the box:

- Your name
- Your address
- Your phone number
- RMA number
- A brief description of the problem

Be sure to pack the product properly. Any shipping damage resulting from inadequate packaging will be your responsibility. FedEx packing or double-boxing is recommended.



**Chauvet reserves the right to use its own discretion to repair or replace returned product(s).**

---

## CONTACT US

### WORLD HEADQUARTERS - Chauvet

#### General Information

Address: 5200 NW 108<sup>th</sup> Avenue  
Sunrise, FL 33351  
Voice: (954) 577-4455  
Fax: (954) 929-5560  
Toll free: (800) 762-1084

#### Technical Support

Voice: (954) 577-4455 (Press 4)  
Fax: (954) 756-8015  
Email: [tech@chauvetlighting.com](mailto:tech@chauvetlighting.com)

World Wide Web [www.chauvetlighting.com](http://www.chauvetlighting.com)

### UNITED KINGDOM AND IRELAND - Chauvet Europe Ltd.

#### General Information

Address: Unit 1C  
Brookhill Road Industrial Estate  
Pinxton, Nottingham, UK  
NG16 6NT  
Voice: +44 (0)1773 511115  
Fax: +44 (0)1773 511110

#### Technical Support

Email: [uktech@chauvetlighting.com](mailto:uktech@chauvetlighting.com)

World Wide Web  
[www.chauvetlighting.co.uk](http://www.chauvetlighting.co.uk)

### MEXICO - Chauvet Mexico

#### General Information

Address: Av. Santa Ana 30  
Parque Industrial Lerma  
Lerma, Mexico C.P. 52000  
Voice: +52 (728) 285-5000

#### Technical Support

Email: [servicio@chauvet.com.mx](mailto:servicio@chauvet.com.mx)

World Wide Web [www.chauvet.com.mx](http://www.chauvet.com.mx)

### CHAUVET EUROPE - Chauvet Europe BVBA

#### General Information

Address: Stokstraat 18  
9770 Kruishoutem  
Belgium  
Voice: +32 9 388 93 97

#### Technical Support

Email: [Eutech@chauvetlighting.eu](mailto:Eutech@chauvetlighting.eu)

World Wide Web [www.chauvetlighting.eu](http://www.chauvetlighting.eu)

Outside the U.S., United Kingdom, Ireland, Mexico, or Benelux contact your dealer. Follow their instructions to request support or to return a product. Visit our website for contact details.