

COLORstrip PiX ILS

User Manual



Edition Notes

The COLORstrip Pix ILS User Manual includes a description, safety precautions, installation, programming, operation, and maintenance instructions for the COLORstrip Pix ILS as of the release date of this edition.

Trademarks

Chauvet, Chauvet DJ, the Chauvet logo, and COLORstrip are registered trademarks or trademarks of Chauvet & Sons, LLC (d/b/a Chauvet and Chauvet Lighting) in the United States and other countries. Other company and product names and logos referred to herein may be trademarks of their respective companies.

Copyright Notice

The works of authorship contained in this manual, including, but not limited to, all designs, text, and images are owned by Chauvet.

© Copyright 2024 Chauvet & Sons, LLC. All rights reserved.

Electronically published by Chauvet in the United States of America.

Manual Use

Chauvet authorizes its customers to download and print this manual for professional information purposes only. Chauvet expressly prohibits the usage, copy, storage, distribution, modification, or printing of this manual or its content for any other purpose without written consent from Chauvet.

Document Printing

For best results, print this document in color, on letter size paper (8.5 x 11 in), double-sided. If using A4 paper (210 x 297 mm), configure the printer to scale the content accordingly.

Intended Audience

Any person installing, operating, and/or maintaining this product should completely read through the guide that shipped with the product, as well as this manual, before installing, operating, or maintaining this product.

Disclaimer

Chauvet believes that the information contained in this manual is accurate in all respects. However, Chauvet assumes no responsibility and specifically disclaims any and all liability to any party for any loss, damage, or disruption caused by any errors or omissions in this document, whether such errors or omissions result from negligence, accident, or any other cause. Chauvet reserves the right to revise the content of this document without any obligation to notify any person or company of such revision; however, Chauvet has no obligation to make, and does not commit to make, any such revisions.

Document Revision

Go to www.chauvetdj.com for the latest version.

Revision	Date	Description
1	07/2024	Initial release.

TABLE OF CONTENTS

1. Before You Begin	1
What Is Included	1
Unpacking Instructions	1
Claims	1
Text Conventions	1
Symbols	1
Safety Notes	2
2. Introduction	3
Product Overview	3
Product Dimensions	3
3. Setup	4
AC Power	4
AC Plug	4
Fuse Replacement	4
Power Linking	5
Mounting	5
Orientation	5
Rigging	5
4. Operation	6
Control Panel Operation	6
Menu Map	6
DMX Configuration	7
Personality and Starting Address	7
D-Fi USB Connectivity	8
D-Fi USB Compatibility	8
D-Fi USB Configuration	8
DMX Channel Assignments and Values	9
8Ch / 3Ch	9
122 / 120	10
Standalone Configuration	16
Static Color Mode	16
Automatic Programs	16
Auto Program Speed	16
Sound-Active Mode	16
Sound Sensitivity	16
Custom Color Mixing	16
Dimmer	16
Connect Mode	17
Factory Reset	17
IRC-6 Infrared Remote Control	18
Wired Master/Slave Mode	19
D-Fi USB Master/Slave Mode	19
ILS Mode	19
5. Maintenance	20
Product Maintenance	20
6. Technical Specifications	21
Contact Us	22
Warranty & Returns	22

1. Before You Begin

What Is Included

- COLORstrip Pix ILS
- Power cable
- Quick Reference Guide

Unpacking Instructions

Carefully unpack the product immediately and check the container to make sure all the parts are in the package and are in good condition.

Claims





If the box or the contents (the product and included accessories) appear damaged from shipping, or show signs of mishandling, notify the carrier immediately, not Chauvet. Failure to report damage to the carrier immediately may invalidate a claim. In addition, keep the box and contents for inspection.

For other issues, such as missing components or parts, damage not related to shipping, or concealed damage, file a claim with Chauvet within 7 days of delivery.

Text Conventions

Convention	Meaning
1–512	A range of values
50/60	A set of values of which only one can be chosen
Settings	A menu option not to be modified
<ENTER>	A key to be pressed on the product’s control panel
ON	A value to be entered or selected

Symbols

Symbol	Meaning
	Electrical warning. Not following these instructions may cause electrical damage to the product, accessories, or the user.
	Critical installation, configuration, or operation information. Not following these instructions may make the product not work, cause damage to the product, or cause harm to the operator.
	Important installation or configuration information. The product may not function correctly if this information is not used.
	Useful information.

Safety Notes

These Safety Notes include important information about installation, use, and maintenance of the COLORstrip Pix ILS.



■ **ALWAYS:**

- ◆ Connect to a grounded circuit.
- ◆ Connect to operating voltages as specified on the product's spec sticker.
- ◆ Disconnect from power before replacing the fuse.
- ◆ Disconnect from its power source during periods of inactivity.
- ◆ Use a safety cable when suspending overhead.
- ◆ Heed all restrictions and warnings on the spec sticker.
- ◆ Mount in a location with at least 20 in (50 cm) of ventilation.
- ◆ Replace the fuse with the same type and rating.

- In the event of a serious operating problem, stop using immediately.

■ **DO NOT:**

- ◆ Open this product or attempt any repairs. It contains no user-serviceable parts.
- ◆ Look at the light source when the product is on.
- ◆ Use if the power cord is crimped or damaged.
- ◆ Disconnect by pulling on the power cord.
- ◆ Allow flammable materials close to the product when it is operating.
- ◆ Touch the housing when it is on.
- ◆ Block any ventilation holes/slots in the housing.
- ◆ Connect to a dimmer or rheostat.
- ◆ Carry the product by its power cord.
- ◆ Operate in temperatures higher than 104°F (40°C).
- ◆ Expose to environments that exceed the Ingress Protection (IP) rating.
- ◆ Expose to rain or moisture.
- ◆ Use outdoors.
- ◆ Submerge.
- ◆ Set this product on a flammable surface.



Keep this User Manual for future use. If the product is sold to someone else, be sure that they also receive this document.

2. Introduction

Product Overview

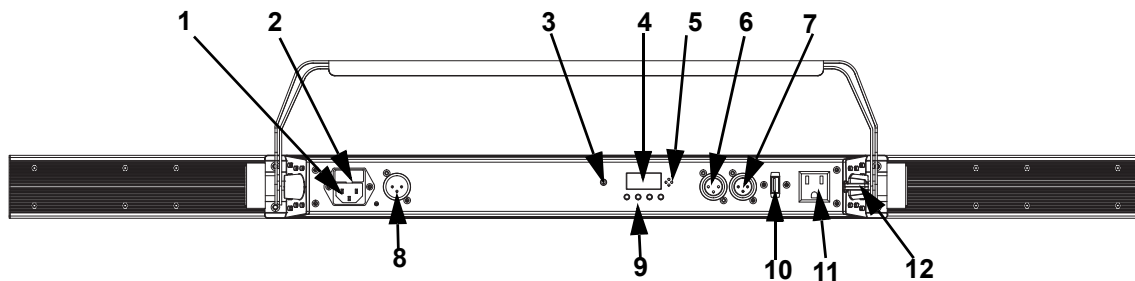

#	Name	#	Name
1	Power in	7	3-Pin DMX out
2	Fuse holder	8	3-Pin DMX in
3	IR sensor	9	Menu buttons
4	Display	10	USB port
5	Microphone	11	Power out
6	Master/slave out	12	Safety loop



WARNING! DO NOT plug anything other than a D-Fi USB into the USB type B port. Doing so may cause damage to the product.

Product Dimensions

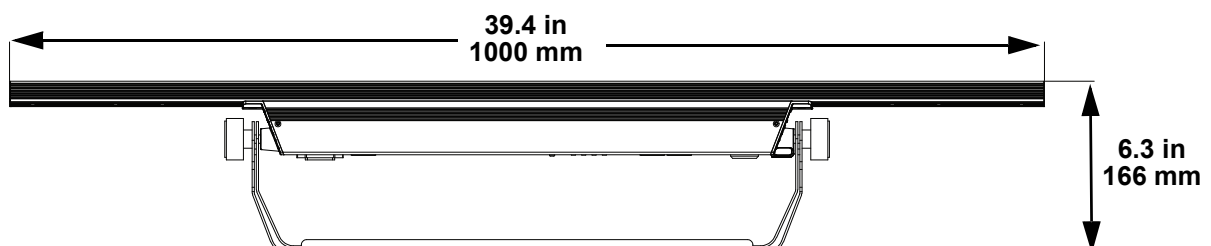
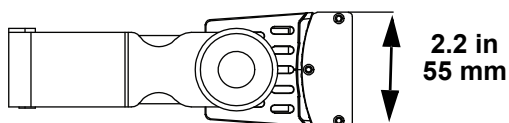

3. Setup

AC Power

The COLORstrip Pix ILS has an auto-ranging power supply and it can work with an input voltage range of 100 to 240 VAC, 50/60 Hz.

To determine the product's power requirements (circuit breaker, power outlet, and wiring), use the current value listed on the label affixed to the product's back panel, or refer to the product's specifications chart. The listed current rating indicates the product's average current draw under normal conditions.



- **Always connect the product to a protected circuit (a circuit breaker or fuse). Make sure the product has an appropriate electrical ground to avoid the risk of electrocution or fire.**
- **To eliminate unnecessary wear and improve its lifespan, during periods of non-use completely disconnect the product from power via breaker or by unplugging it.**



Never connect the product to a rheostat (variable resistor) or dimmer circuit, even if the rheostat or dimmer channel serves only as a 0 to 100% switch.

AC Plug

This product can be connected to a dimmer or rheostat, by plugging in to a standard outlet controlled by a dimmer or rheostat, or by splicing the power cable and connecting to the included track adapter.

Connection	Wire (U.S.)	Wire (Europe)	Screw Color
AC Live	Black	Brown	Yellow/Brass
AC Neutral	White	Blue	Silver
AC Ground	Green/Yellow	Green/Yellow	Green/Silver

Fuse Replacement

1. Disconnect the product from power.
2. Wedge the tip of a flat-head screwdriver into the slot of the fuse holder.
3. Pry the fuse holder out of the housing.
4. Remove the blown fuse from the holder and replace with a fuse of the exact same type and rating.
5. Insert the fuse holder back in place and reconnect power.

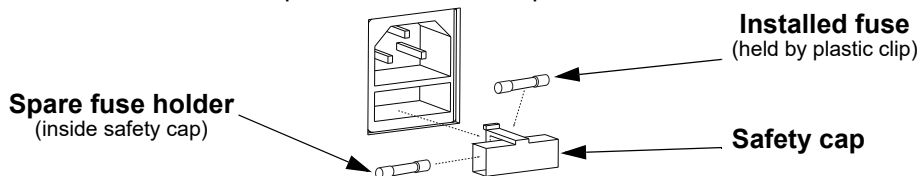

Disconnect the product from the power outlet before replacing the fuse.



Always replace a blown fuse with one of the same type and rating.

Power Linking

This product provides power linking via the outlet located in the back of the product. See the diagram below for further explanation.

Power Linking Diagram

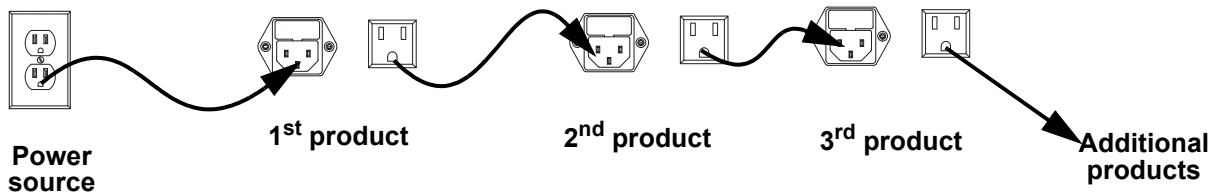

It is possible to link up to 7 COLORstrip Pix ILS products on 120 VAC or up to 10 products on 230 VAC.



The power linking diagram shown above corresponds to the North American version of the product **ONLY!** If using the product in other markets, consult with the local Chauvet distributor as power linking connectors and requirements may differ by country or region.

Mounting

Before mounting the product, read and follow the safety recommendations indicated in the [Safety Notes](#).

Orientation

The COLORstrip Pix ILS may be mounted in any position; however, make sure adequate ventilation is provided around the product.

Rigging

- Before deciding on a location for the product, always make sure there is easy access to the product for maintenance and programming.
- Make sure that the structure and attachment points can support the weight before hanging the product (see the [Technical Specifications](#)).
- When mounting the product overhead, always use a safety cable. Mount the product securely to a rigging point, such as an elevated platform or a truss.
- When rigging the product onto a truss, use a mounting clamp of appropriate weight capacity. The bracket has a 13-mm hole, which is appropriate for this purpose.
- The bracket adjustment knobs allow for directional adjustment when aiming the product to the desired angle. Only loosen or tighten the bracket knobs manually. Using tools could damage the knobs.
- When power linking multiple products, mount the products close enough for power linking cables to reach.
- When mounting the product on the floor, make sure that the product and cables are away from people and vehicles.

Mounting Diagram

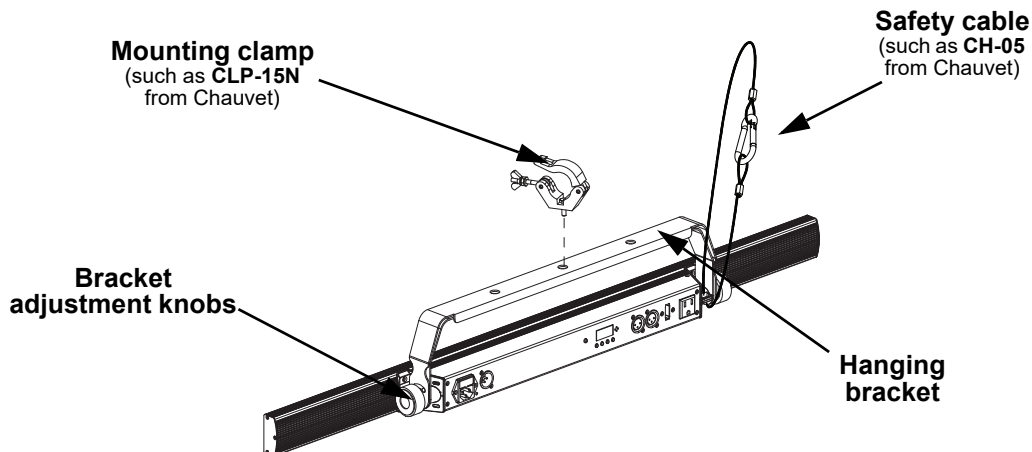

4. Operation

Control Panel Operation

To access the control panel functions, use the four buttons located underneath the display. Please refer to the [Product Overview](#) to see the button locations on the control panel.

Button	Function
<MENU>	Press to find an operation mode or to back out of the current menu option
<UP>	Press to scroll up the list of options or to find a higher value
<DOWN>	Press to scroll down the list of options or to find a lower value
<ENTER>	Press to activate a menu option or a selected value

Menu Map

Refer to the COLORstrip Pix ILS product page on www.chauvetdj.com for the latest menu map and software.

Mode	Programming Levels		Description	
DMX Mode	3Ch	d001–510	3-channel DMX mode	
	8Ch	d001–505	8-channel DMX mode	
	120	d001–393	120-channel DMX mode	
	122	d001–391	122-channel DMX mode	
Static Colors	C--	C 1–19	Static colors	
Programs	P--	P 1–16	Automatic programs	
Auto Speed	S--	S001–100	Program speed for P 1–16	
Sound Mode	Snd	Snd	Activates the sound-active program	
Sensitivity	SEnS	u 1–100	Sets sound sensitivity	
Custom Color Mixing	U--	r 0–255	Custom static colors Combine red, green, and blue	
		G 0–255		
		b 0–255		
Dimmer	dIM	oFF	Sets dimmer mode	
		dIM1		
		dIM2		
		dIM3		
Infrared Mode	SEt	ir	on	Turns infrared on or off
			oFF	
		ConC	Co01–16	Selects runway effect
			rEst	no YES
Slave mode	SLAV	SL01–16	Enable Master slave with other products	
ILS Mode	iLS	iLS 1–4	Sets ILS mode	

DMX Configuration

The COLORstrip Pix ILS works with a DMX controller. Information about DMX is in the Chauvet DMX Primer, which is available from the Chauvet website chauvetlighting.com/downloads/DMX_Primer_rev05_WO.pdf.

Personality and Starting Address

The COLORstrip Pix ILS uses up to 122 DMX channels in the **122Ch** DMX mode, which defines the highest configurable address to **391**.

When selecting a starting DMX address, always consider the number of DMX channels the DMX mode uses. If the starting address is set too high, access to some channels could be restricted.

For information about the DMX protocol, download the DMX Primer from www.chauvetdj.com.

To select the personality and starting address, do the following:

1. Press **<MENU>** repeatedly until **3Ch**, **8Ch**, **120**, or **122** shows on the display.
2. Press **<ENTER>**.
3. Use **<UP>** or **<DOWN>** to select the starting address, from **d. 1–391**.
4. Press **<ENTER>**.

D-Fi USB Connectivity

The COLORstrip Pix ILS is able to become a D-Fi wireless receiver/transmitter with the use of the D-Fi USB from Chauvet DJ. Simply set the product's DMX Personality and DMX Address, set the DIP switch D-Fi receiving/transmitting channel, then plug it into the D-Fi USB port.



WARNING! DO NOT plug anything other than a D-Fi USB into the USB type B port. Doing so may cause damage to the product.



Once plugged in, the D-Fi USB will take over the product. Wired DMX and manual display control / menu buttons will be unavailable until the D-Fi USB is unplugged. The priority levels are:

1. D-Fi USB
2. Wired DMX
3. Manual Digital Display/Menu Buttons

D-Fi USB Compatibility

The D-Fi USB can receive a DMX signal from the D-Fi Hub and the FlareCON Air 2 as well as other D-Fi USB products.

D-Fi USB Configuration

1. Set the DMX Personality and DMX address on the COLORstrip Pix ILS.
2. Use the Chart provided to set **BOTH**:
 - the Channel, and then
 - The Receiving or Transmitting option

NOTE: DIP Switch 5 is for Transmitting OR Receiving, please choose carefully.

D-Fi USB DIP Switch Channels

Receiving						Receiving						Transmitting						Transmitting					
Ch.	1	2	3	4	T/R	Ch.	1	2	3	4	T/R	Ch.	1	2	3	4	T/R	Ch.	1	2	3	4	T/R
1	█	█	█	█	█	9	█	█	█	█	█	1	█	█	█	█	█	9	█	█	█	█	█
2	█	█	█	█	█	10	█	█	█	█	█	2	█	█	█	█	█	10	█	█	█	█	█
3	█	█	█	█	█	11	█	█	█	█	█	3	█	█	█	█	█	11	█	█	█	█	█
4	█	█	█	█	█	12	█	█	█	█	█	4	█	█	█	█	█	12	█	█	█	█	█
5	█	█	█	█	█	13	█	█	█	█	█	5	█	█	█	█	█	13	█	█	█	█	█
6	█	█	█	█	█	14	█	█	█	█	█	6	█	█	█	█	█	14	█	█	█	█	█
7	█	█	█	█	█	15	█	█	█	█	█	7	█	█	█	█	█	15	█	█	█	█	█
8	█	█	█	█	█	16	█	█	█	█	█	8	█	█	█	█	█	16	█	█	█	█	█

DMX Channel Assignments and Values

8Ch / 3Ch

3Ch	8Ch	Function	Value	Percent/Setting
–	1	Dimmer	000 ⇔ 255	0–100%
1	2	Red	000 ⇔ 255	0–100%
2	3	Green	000 ⇔ 255	0–100%
3	4	Blue	000 ⇔ 255	0–100%
–	5	Color macros	000 ⇔ 010	No function
			011 ⇔ 255	Color macros
–	6	Strobe	000 ⇔ 010	No function
			011 ⇔ 255	Strobe, slow to fast
			000 ⇔ 010	No function
			011 ⇔ 025	Auto program 1
			026 ⇔ 040	Auto program 2
			041 ⇔ 055	Auto program 3
			056 ⇔ 070	Auto program 4
			071 ⇔ 085	Auto program 5
			086 ⇔ 100	Auto program 6
			101 ⇔ 115	Auto program 7
			116 ⇔ 130	Auto program 8
			131 ⇔ 145	Auto program 9
			146 ⇔ 160	Auto program 10
			161 ⇔ 175	Auto program 11
			176 ⇔ 190	Auto program 12
			191 ⇔ 205	Auto program 13
			206 ⇔ 220	Auto program 14
			221 ⇔ 235	Auto program 15
			236 ⇔ 250	Auto program 16
			251 ⇔ 255	Sound-active program
–	8	Program speed (When Ch. 7 is 011 ⇔ 250)	000 ⇔ 255	Program speed, slow to fast

122 / 120

120	122	Function	Value	Percent/Setting
1	1	Red 1	000 ⇔ 003	No function
			004 ⇔ 255	0–100%
2	2	Green 1	000 ⇔ 003	No function
			004 ⇔ 255	0–100%
3	3	Blue 1	000 ⇔ 003	No function
			004 ⇔ 255	0–100%
4	4	Red 2	000 ⇔ 003	No function
			004 ⇔ 255	0–100%
5	5	Green 2	000 ⇔ 003	No function
			004 ⇔ 255	0–100%
6	6	Blue 2	000 ⇔ 003	No function
			004 ⇔ 255	0–100%
7	7	Red 3	000 ⇔ 003	No function
			004 ⇔ 255	0–100%
8	8	Green 3	000 ⇔ 003	No function
			004 ⇔ 255	0–100%
9	9	Blue 3	000 ⇔ 003	No function
			004 ⇔ 255	0–100%
10	10	Red 4	000 ⇔ 003	No function
			004 ⇔ 255	0–100%
11	11	Green 4	000 ⇔ 003	No function
			004 ⇔ 255	0–100%
12	12	Blue 4	000 ⇔ 003	No function
			004 ⇔ 255	0–100%
13	13	Red 5	000 ⇔ 003	No function
			004 ⇔ 255	0–100%
14	14	Green 5	000 ⇔ 003	No function
			004 ⇔ 255	0–100%
15	15	Blue 5	000 ⇔ 003	No function
			004 ⇔ 255	0–100%
16	16	Red 6	000 ⇔ 003	No function
			004 ⇔ 255	0–100%
17	17	Green 6	000 ⇔ 003	No function
			004 ⇔ 255	0–100%
18	18	Blue 6	000 ⇔ 003	No function
			004 ⇔ 255	0–100%
19	19	Red 7	000 ⇔ 003	No function
			004 ⇔ 255	0–100%
20	20	Green 7	000 ⇔ 003	No function
			004 ⇔ 255	0–100%
21	21	Blue 7	000 ⇔ 003	No function
			004 ⇔ 255	0–100%
22	22	Red 8	000 ⇔ 003	No function
			004 ⇔ 255	0–100%
23	23	Green 8	000 ⇔ 003	No function
			004 ⇔ 255	0–100%

120	122	Function	Value	Percent/Setting
24	24	Blue 8	000 ⇔ 003	No function
			004 ⇔ 255	0–100%
25	25	Red 9	000 ⇔ 003	No function
			004 ⇔ 255	0–100%
26	26	Green 9	000 ⇔ 003	No function
			004 ⇔ 255	0–100%
27	27	Blue 9	000 ⇔ 003	No function
			004 ⇔ 255	0–100%
28	28	Red 10	000 ⇔ 003	No function
			004 ⇔ 255	0–100%
29	29	Green 10	000 ⇔ 003	No function
			004 ⇔ 255	0–100%
30	30	Blue 10	000 ⇔ 003	No function
			004 ⇔ 255	0–100%
31	31	Red 11	000 ⇔ 003	No function
			004 ⇔ 255	0–100%
32	32	Green 11	000 ⇔ 003	No function
			004 ⇔ 255	0–100%
33	33	Blue 11	000 ⇔ 003	No function
			004 ⇔ 255	0–100%
34	34	Red 12	000 ⇔ 003	No function
			004 ⇔ 255	0–100%
35	35	Green 12	000 ⇔ 003	No function
			004 ⇔ 255	0–100%
36	36	Blue 12	000 ⇔ 003	No function
			004 ⇔ 255	0–100%
37	37	Red 13	000 ⇔ 003	No function
			004 ⇔ 255	0–100%
38	38	Green 13	000 ⇔ 003	No function
			004 ⇔ 255	0–100%
39	39	Blue 13	000 ⇔ 003	No function
			004 ⇔ 255	0–100%
40	40	Red 14	000 ⇔ 003	No function
			004 ⇔ 255	0–100%
41	41	Green 14	000 ⇔ 003	No function
			004 ⇔ 255	0–100%
42	42	Blue 14	000 ⇔ 003	No function
			004 ⇔ 255	0–100%
43	43	Red15	000 ⇔ 003	No function
			004 ⇔ 255	0–100%
44	44	Green 15	000 ⇔ 003	No function
			004 ⇔ 255	0–100%
45	45	Blue 15	000 ⇔ 003	No function
			004 ⇔ 255	0–100%
46	46	Red 16	000 ⇔ 003	No function
			004 ⇔ 255	0–100%

Operation

120	122	Function	Value	Percent/Setting
47	47	Green 16	000 ⇔ 003	No function
			004 ⇔ 255	0–100%
48	48	Blue 16	000 ⇔ 003	No function
			004 ⇔ 255	0–100%
49	49	Red 17	000 ⇔ 003	No function
			004 ⇔ 255	0–100%
50	50	Green 17	000 ⇔ 003	No function
			004 ⇔ 255	0–100%
51	51	Blue 17	000 ⇔ 003	No function
			004 ⇔ 255	0–100%
52	52	Red 18	000 ⇔ 003	No function
			004 ⇔ 255	0–100%
53	53	Green 18	000 ⇔ 003	No function
			004 ⇔ 255	0–100%
54	54	Blue 18	000 ⇔ 003	No function
			004 ⇔ 255	0–100%
55	55	Red 19	000 ⇔ 003	No function
			004 ⇔ 255	0–100%
56	56	Green 19	000 ⇔ 003	No function
			004 ⇔ 255	0–100%
57	57	Blue 19	000 ⇔ 003	No function
			004 ⇔ 255	0–100%
58	58	Red 20	000 ⇔ 003	No function
			004 ⇔ 255	0–100%
59	59	Green 20	000 ⇔ 003	No function
			004 ⇔ 255	0–100%
60	60	Blue 20	000 ⇔ 003	No function
			004 ⇔ 255	0–100%
61	61	Red 21	000 ⇔ 003	No function
			004 ⇔ 255	0–100%
62	62	Green 21	000 ⇔ 003	No function
			004 ⇔ 255	0–100%
63	63	Blue 21	000 ⇔ 003	No function
			004 ⇔ 255	0–100%
64	64	Red 22	000 ⇔ 003	No function
			004 ⇔ 255	0–100%
65	65	Green 22	000 ⇔ 003	No function
			004 ⇔ 255	0–100%
66	66	Blue 22	000 ⇔ 003	No function
			004 ⇔ 255	0–100%
67	67	Red 23	000 ⇔ 003	No function
			004 ⇔ 255	0–100%
68	68	Green 23	000 ⇔ 003	No function
			004 ⇔ 255	0–100%
69	69	Blue 23	000 ⇔ 003	No function
			004 ⇔ 255	0–100%

120	122	Function	Value	Percent/Setting
70	70	Red 24	000 ⇔ 003	No function
			004 ⇔ 255	0–100%
71	71	Green 24	000 ⇔ 003	No function
			004 ⇔ 255	0–100%
72	72	Blue 24	000 ⇔ 003	No function
			004 ⇔ 255	0–100%
73	73	Red 25	000 ⇔ 003	No function
			004 ⇔ 255	0–100%
74	74	Green 25	000 ⇔ 003	No function
			004 ⇔ 255	0–100%
75	75	Blue 25	000 ⇔ 003	No function
			004 ⇔ 255	0–100%
76	76	Red 26	000 ⇔ 003	No function
			004 ⇔ 255	0–100%
77	77	Green 26	000 ⇔ 003	No function
			004 ⇔ 255	0–100%
78	78	Blue 26	000 ⇔ 003	No function
			004 ⇔ 255	0–100%
79	79	Red 27	000 ⇔ 003	No function
			004 ⇔ 255	0–100%
80	80	Green 27	000 ⇔ 003	No function
			004 ⇔ 255	0–100%
81	81	Blue 27	000 ⇔ 003	No function
			004 ⇔ 255	0–100%
82	82	Red 28	000 ⇔ 003	No function
			004 ⇔ 255	0–100%
83	83	Green 28	000 ⇔ 003	No function
			004 ⇔ 255	0–100%
84	84	Blue 28	000 ⇔ 003	No function
			004 ⇔ 255	0–100%
85	85	Red 29	000 ⇔ 003	No function
			004 ⇔ 255	0–100%
86	86	Green 29	000 ⇔ 003	No function
			004 ⇔ 255	0–100%
87	87	Blue 29	000 ⇔ 003	No function
			004 ⇔ 255	0–100%
88	88	Red 30	000 ⇔ 003	No function
			004 ⇔ 255	0–100%
89	89	Green 30	000 ⇔ 003	No function
			004 ⇔ 255	0–100%
90	90	Blue 30	000 ⇔ 003	No function
			004 ⇔ 255	0–100%
91	91	Red 31	000 ⇔ 003	No function
			004 ⇔ 255	0–100%
92	92	Green 31	000 ⇔ 003	No function
			004 ⇔ 255	0–100%

120	122	Function	Value	Percent/Setting
93	93	Blue 31	000 ⇔ 003	No function
			004 ⇔ 255	0–100%
94	94	Red 32	000 ⇔ 003	No function
			004 ⇔ 255	0–100%
95	95	Green 32	000 ⇔ 003	No function
			004 ⇔ 255	0–100%
96	96	Blue 32	000 ⇔ 003	No function
			004 ⇔ 255	0–100%
97	97	Red 33	000 ⇔ 003	No function
			004 ⇔ 255	0–100%
98	98	Green 33	000 ⇔ 003	No function
			004 ⇔ 255	0–100%
99	99	Blue 33	000 ⇔ 003	No function
			004 ⇔ 255	0–100%
100	100	Red 34	000 ⇔ 003	No function
			004 ⇔ 255	0–100%
101	101	Green 34	000 ⇔ 003	No function
			004 ⇔ 255	0–100%
102	102	Blue 34	000 ⇔ 003	No function
			004 ⇔ 255	0–100%
103	103	Red 35	000 ⇔ 003	No function
			004 ⇔ 255	0–100%
104	104	Green 35	000 ⇔ 003	No function
			004 ⇔ 255	0–100%
105	105	Blue 35	000 ⇔ 003	No function
			004 ⇔ 255	0–100%
106	106	Red 36	000 ⇔ 003	No function
			004 ⇔ 255	0–100%
107	107	Green 36	000 ⇔ 003	No function
			004 ⇔ 255	0–100%
108	108	Blue 36	000 ⇔ 003	No function
			004 ⇔ 255	0–100%
109	109	Red 37	000 ⇔ 003	No function
			004 ⇔ 255	0–100%
110	110	Green 37	000 ⇔ 003	No function
			004 ⇔ 255	0–100%
111	111	Blue 37	000 ⇔ 003	No function
			004 ⇔ 255	0–100%
112	112	Red 38	000 ⇔ 003	No function
			004 ⇔ 255	0–100%
113	113	Green 38	000 ⇔ 003	No function
			004 ⇔ 255	0–100%
114	114	Blue 38	000 ⇔ 003	No function
			004 ⇔ 255	0–100%
115	115	Red 39	000 ⇔ 003	No function
			004 ⇔ 255	0–100%

120	122	Function	Value	Percent/Setting
116	116	Green 39	000 ⇔ 003	No function
			004 ⇔ 255	0–100%
117	117	Blue 39	000 ⇔ 003	No function
			004 ⇔ 255	0–100%
118	118	Red 40	000 ⇔ 003	No function
			004 ⇔ 255	0–100%
119	119	Green 40	000 ⇔ 003	No function
			004 ⇔ 255	0–100%
120	120	Blue 40	000 ⇔ 003	No function
			004 ⇔ 255	0–100%
–	121	Strobe	000 ⇔ 010	No function
			011 ⇔ 255	Strobe, slow to fast
–	122	Dimmer	000 ⇔ 255	0–100%

Standalone Configuration

Set the product in one of the standalone modes to operate without a DMX controller.



Never connect a product that is operating in any standalone mode to a DMX string connected to a DMX controller. Products in standalone mode may transmit DMX signals that could interfere with the DMX signals from the controller.

Static Color Mode

To run the COLORstrip Pix ILS with a static color, follow the instructions below.

1. Press **<MENU>** repeatedly until **C--** shows on the display.
2. Press **<ENTER>**.
3. Use **<UP>** or **<DOWN>** to select the desired static color from **C 1–19**.
4. Press **<ENTER>**.

Automatic Programs

To run the COLORstrip Pix ILS with an automatic program, follow the instructions below.

1. Press **<MENU>** repeatedly until **P--** shows on the display.
2. Press **<ENTER>**.
3. Use **<UP>** or **<DOWN>** to select the desired static color from **P 1–16**.
4. Press **<ENTER>**.

Auto Program Speed

To set the speed for automatic programs, follow the instructions below:

1. Press **<MENU>** repeatedly until **S--** shows on the display.
2. Press **<ENTER>**.
3. Use **<UP>** or **<DOWN>** to increase or decrease the automatic program speed, from **S001–100**.
4. Press **<ENTER>**.

Sound-Active Mode

To run the COLORstrip Pix ILS with a sound-active program, follow the instructions below.

1. Press **<MENU>** repeatedly until **Snd** shows on the display.
2. Press **<ENTER>**.

Sound Sensitivity

To set the sound sensitivity of the product, do the following:

1. Press **<MENU>** repeatedly until **sEnS** shows on the display.
2. Press **<ENTER>**.
3. Use **<UP>** or **<DOWN>** to increase or decrease the sound sensitivity, from **u 1–100**.
4. Press **<ENTER>**.



The product will only respond to low frequencies of music (bass and drums).

Custom Color Mixing

To run the COLORstrip Pix ILS with a custom static color, follow the instructions below.

1. Press **<MENU>** repeatedly until **U--** shows on the display.
2. Press **<ENTER>**.
3. Press **<ENTER>** to cycle through the options, **r _ _ _** (red), **G _ _ _** (green), and **b _ _ _** (blue).
4. Use **<UP>** or **<DOWN>** to increase or decrease the selected value from **_000–255**.
5. Repeat steps 3-4 until the product output is set as desired.

Dimmer

To set the dimmer of the product, do the following:

1. Press **<MENU>** repeatedly until **dim** shows on the display.
2. Press **<ENTER>**.
3. Use **<UP>** or **<DOWN>** to increase or decrease the sound sensitivity, from **dim1** (fast) to **dim3** (slow) or **oFF**.
4. Press **<ENTER>**.

Connect Mode

To run connected products with a runway effect, do the following:

1. Press **<MENU>** repeatedly until **SEt** shows on the display.
2. Press **<ENTER>**.
3. Use **<UP>** or **<DOWN>** to select **ConC**.
4. Press **<ENTER>**.
5. Use **<UP>** or **<DOWN>** to select a connecting fixtures from **Co01–16**.
6. Press **<ENTER>**.

Factory Reset

To reset the product, do the following:

1. Press **<MENU>** repeatedly until **SEt** shows on the display.
2. Press **<ENTER>**.
3. Use **<UP>** or **<DOWN>** to select **rEST** (reset).
4. Press **<ENTER>**.
5. Use **<UP>** or **<DOWN>** to select from **no** (cancel) or **YES** (reset).
6. Press **<ENTER>**.

IRC-6 Infrared Remote Control

The COLORstrip Pix ILS is compatible with the IRC-6 infrared remote control from Chauvet.

To enable or disable IRC-6 functionality, do the following:

1. Press **<MENU>** repeatedly until **SEt** shows on the display.
2. Press **<ENTER>**.
3. Press **<ENTER>** to select **ir**.
4. Press **<ENTER>**.
5. Use **<UP>** or **<DOWN>** to select from **on** (enable) or **oFF** (disable).
6. Press **<ENTER>**.

Consult the table below to operate the COLORstrip Pix ILS with the IRC-6.

IRC-6	Button	Function
	<AUTO>	Press to activate automatic mode, then press again or use <+> or <-> to select a program
	<SPEED>	Press then use <+> or <-> to increase or decrease speed
	<SOUND>	Press to activate sound-active mode
	<SENSITIVITY>	Press then use <+> or <-> to increase or decrease sensitivity
	<STROBE>	Press to toggle strobe, then use <+> or <-> to increase or decrease strobe speed
	<%>	Press then use <+> or <-> to increase or decrease the dimmer
	<FADE>	Press to activate fade mode, then use <+> or <-> to select a fading program
	<MANUAL>	Press to enable manual color control
	<R>	Press then use <+> or <-> to increase or decrease the red value
	<G>	Press then use <+> or <-> to increase or decrease the green value
		Press then use <+> or <-> to increase or decrease the blue value
	<+>	Press to increase speed, sensitivity, or the dimmer/color value, or to scroll up the list of programs
	<->	Press to decrease speed, sensitivity, or the dimmer/color value, or to scroll down the list of programs
	<0>-<9>	Press to select a preset static color
	<BLACK OUT>	Press to turn off all the lights until the button is pressed again. NOTE: The IRC-6 will not respond to any inputs when Black Out is activated. If the product does not respond when a button is pressed, try pressing <BLACK OUT> . Black Out may have been activated.

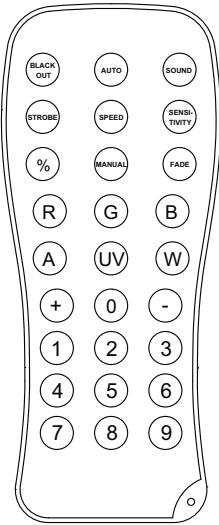

- Any setting on the IRC-6 will be saved until the system is rebooted. The system will revert to Auto Mode after reboot.
- The buttons on the IRC-6 not listed above are reserved for future use.

Wired Master/Slave Mode

The Master/Slave mode allows a single COLORstrip Pix ILS product (the “master”) to control the actions of one or more COLORstrip Pix ILS products (the “slaves”) without the need of a DMX controller. The master product will be set to operate in either standalone mode or with the IRC-6, while the slave products will be set to operate in slave mode. Once set and connected, the slave products will operate in unison with the master product.

Configure the products as indicated below.

Slave products:

1. Press **<MENU>** repeatedly until **SLAV** shows on the display.
2. Press **<ENTER>**.
3. Use **<UP>** or **<DOWN>** to select from **SL01-16**.
4. Press **<ENTER>**.
5. Connect the DMX input of the first slave product to the DMX output of the master product.
6. Connect DMX input of the subsequent slave products to the DMX output of previous slave product.
7. Finish setting and connecting all the slave products.

Master product:

1. Set the master product to operate in standalone mode or with the IRC-6.
2. Make the master product the first product in the DMX daisy chain.



- **Configure all the slave products before connecting the master to the daisy chain.**
- **Never connect a DMX controller to a DMX string configured for Master/Slave operation because the controller may interfere with the signals from the master.**
- **Do not connect more than 31 slaves to the master.**

D-Fi USB Master/Slave Mode

The D-Fi USB allows a single COLORstrip Pix ILS product (the “master”) to control the actions of one or more COLORstrip Pix ILS products (the “slaves”) without the need of a DMX controller or DMX cables. The master (transmitter) product will be set to operate in either standalone mode or with the IRC-6, while the slave (receiver) products will be set to operate in slave mode. Once set and connected, the slave products will operate in unison with the master product. Configure the products as indicated below.

Slave products:

1. Press **<MENU>** repeatedly until **3Ch** shows on the display.
2. Press **<ENTER>**.
3. Use **<UP>** or **<DOWN>** to set the starting address to **d 1**.
4. Press **<ENTER>**.
5. Set the D-Fi USB to receive on a specific channel, 1–16.
6. Plug in the D-Fi USB.
7. Finish setting and connecting all the slave products.

Master product:

1. Set the master product to operate in standalone mode.
2. Set the D-Fi USB to transmit on the D-Fi channel the slaves are receiving on.
3. Plug in the D-Fi USB.



- **All products must be set to the same DMX personality, DMX address, and D-Fi channel.**
- **Configure all the slave products before configuring the master to transmit.**
- **Never connect a DMX controller to a D-Fi channel configured for Master/Slave operation because the controller may interfere with the signals from the master.**

ILS Mode

ILS (Integrated Lighting System) provides 4 modes that synchronize with the GigBAR MOVE+ILS: Modes 1 and 3 synchronize with side 1 of the GigBAR MOVE+ILS, whereas modes 2 and 4 synchronize with side 2 of the GigBAR MOVE+ILS. When linked, effects will sync with the most similar effect on the selected side of the GigBAR MOVE+ILS: Kinta effects will sync with one of the kintas, moving heads will sync with one of the moving heads, and wash effects will sync with one of the pars. Laser effects will sync with the laser, and strobe effects will sync with the strobe effects regardless of ILS mode. This product will synchronize with the par effect on the selected side of the GigBAR MOVE+ILS.

To set the COLORstrip Pix ILS to respond to an ILS signal:

1. Press **<MENU>** repeatedly until **iLS** shows on the display.
2. Use **<UP>** or **<DOWN>** to select from **iLS1** (side 1), **iLS2** (side 2), **iLS3** (side 1), or **iLS4** (side 2).
3. Press **<ENTER>**.

5. Maintenance

Product Maintenance

Dust build-up reduces light output performance and can cause overheating. This can lead to reduction of the light source's life and/or mechanical wear. To maintain optimum performance and minimize wear, clean all lighting products at least twice a month. However, be aware that usage and environmental conditions could be contributing factors to increase the cleaning frequency.

To clean the product, follow the instructions below:

1. Unplug the product from power.
2. Wait until the product is at room temperature.
3. Use a vacuum (or dry compressed air) and a soft brush to remove dust collected on the external surface/vents.
4. Clean all transparent surfaces with a mild soap solution, ammonia-free glass cleaner, or isopropyl alcohol.
5. Apply the solution directly to a soft, lint free cotton cloth or a lens cleaning tissue.
6. Softly drag any dirt or grime to the outside of the transparent surface.
7. Gently polish the transparent surfaces until they are free of haze and lint.



Always dry the transparent surfaces carefully after cleaning them.

6. Technical Specifications

Dimensions and Weight

Length	Width	Height	Weight
38.9 in (987 mm)	2 in (49 mm)	6.2 in (157 mm)	6.2 lb (2.8 kg)

Note: Dimensions in inches are rounded.

Power

Power Supply Type	Range	Voltage Selection
Switching (internal)	100 to 240 VAC, 50/60 Hz	Auto-ranging

Parameter	120 V, 60 Hz	230 V, 50 Hz
Consumption	79 W	77 W
Operating Current	1.2 A	0.8 A
Power linking current (products)	8 A (7 products)	8 A (10 products)
Fuse	T 2A, 250V	T 2A, 250V

Power I/O	U.S./Worldwide	UK/Europe
Power input connector	IEC	IEC
Power output connector	Edison	IEC
Power cable plug	Edison (U.S.)	Local Plug

Light Source

Type	Color	Quantity	Power	Current	Lifespan
LED	Tri-color	40	2 W	0.8 A	50,000 hours

Photometrics

Strobe Rate	PWM Frequency	Beam Angle	Field Angle	Illuminance @ 2m	Lumens
0 to 20Hz	1200Hz	14°	24°	4,967 lux	1,491

Thermal

Maximum External Temperature	Cooling System
104 °F (40 °C)	Convection

DMX

I/O Connector	Channel Range
3-pin XLR	3, 8, 120, or 122

Ordering

Product Name	Item Code	UPC Number
COLORstrip Pix ILS	10032309	781462226572



Contact Us

General Information	Technical Support
Chauvet World Headquarters	
Address: 3360 Davie Rd., Suite 509 Davie, FL 33314 Voice: (954) 577-4455 Fax: (954) 929-5560 Toll Free: (800) 762-1084	Voice: (844) 393-7575 Fax: (954) 756-8015 Email: chauvetcs@chauvetlighting.com Website: www.chauvetdj.com
Chauvet U.K.	
Address: Pod 1 EVO Park Little Oak Drive, Sherwood Park Nottinghamshire, NG15 0EB UK Voice: +44 (0) 1773 511115 Fax: +44 (0) 1773 511110	Email: UKtech@chauvetlighting.eu Website: www.chauvetdj.eu
Chauvet Benelux	
Address: Stokstraat 18 9770 Kruishoutem Belgium Voice: +32 9 388 93 97	Email: BNLtech@chauvetlighting.eu Website: www.chauvetdj.eu
Chauvet France	
Address: 3, Rue Ampère 91380 Chilly-Mazarin France Voice: +33 1 78 85 33 59	Email: FRtech@chauvetlighting.fr Website: www.chauvetdj.eu
Chauvet Germany	
Address: Bruno-Bürgel-Str. 11 28759 Bremen Germany Voice: +49 421 62 60 20	Email: DEtech@chauvetlighting.de Website: www.chauvetdj.eu
Chauvet Mexico	
Address: Av. de las Partidas 34 - 3B (Entrance by Calle 2) Zona Industrial Lerma Lerma, Edo. de México, CP 52000 Voice: +52 (728) 690-2010	Email: servicio@chauvet.com.mx Website: www.chauvetdj.mx

Warranty & Returns

For warranty terms and conditions and return information, please visit our website.

For customers in the United States and Mexico: www.chauvetlighting.com/warranty-registration.

For customers in the United Kingdom, Republic of Ireland, Belgium, the Netherlands, Luxembourg, France, and Germany: www.chauvetlighting.eu/warranty-registration.